

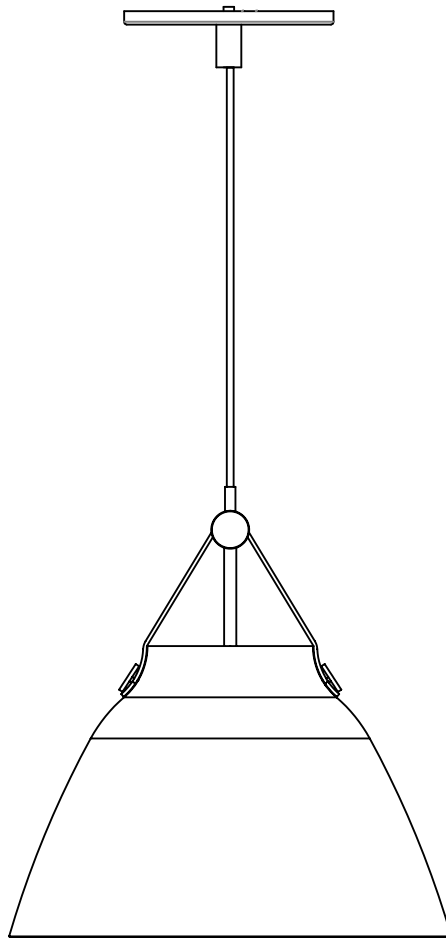

PRODUCT NAME: Nordic Pendant
ITEM NUMBER: 11358

Please consult your electrician for hanging fixture and wiring.



Bulb(not included): 1*A19 MAX60W E26

IMPORTANT: Turn off the power at the main fuse or circuit breaker box before starting installation

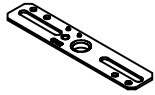

(B) Mounting bracket



(C) ceiling cover



(D) Mounting screws



(E) Threaded tube

Locate all hardware & components before discarding packaging

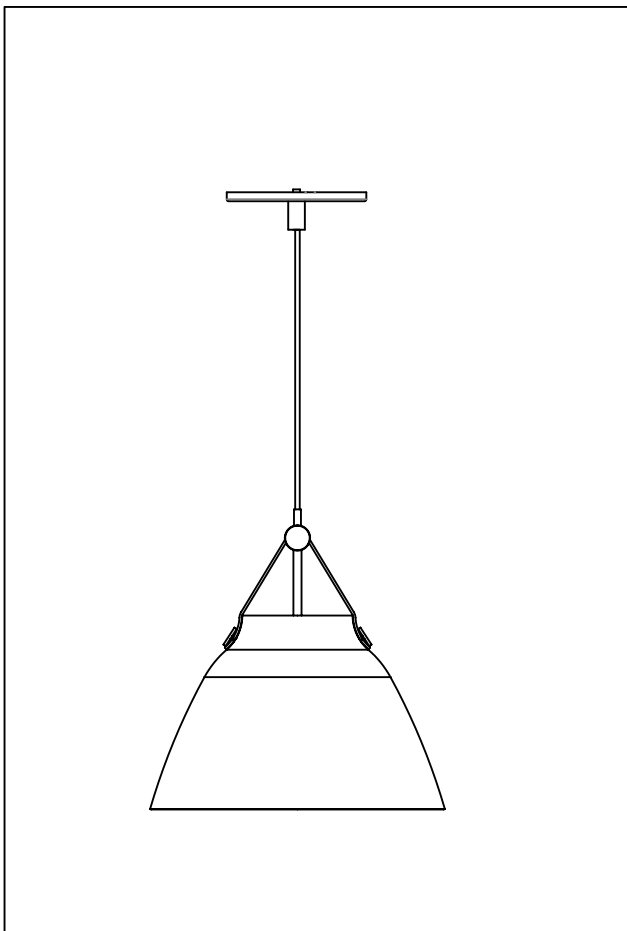

1.)

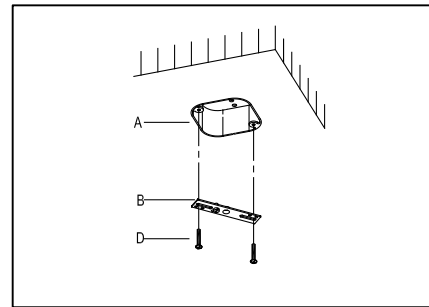

Step1 :Remove mounting bracket from fixture and install to electrical box.

2.)

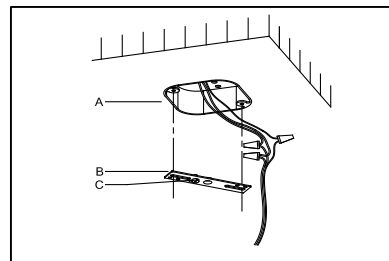

Step2 :Adjust wire length to desired mounting height, and tighten strain relief screws to secure. Wire fixture to wires in outlet box. Green wire is for Ground.

3.)

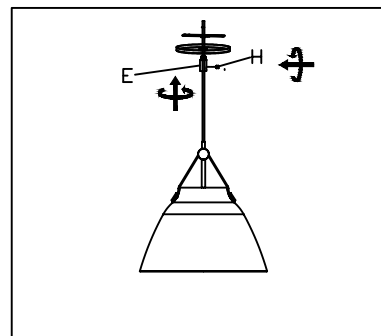

Step3 :Install fixture to bracket and tighten screws at the ends of the canopy to secure. Install bulb into socket.

Cleaning & Care:
Clean with soft cloth and a mild detergent.
Do not use abrasive cleaner.