

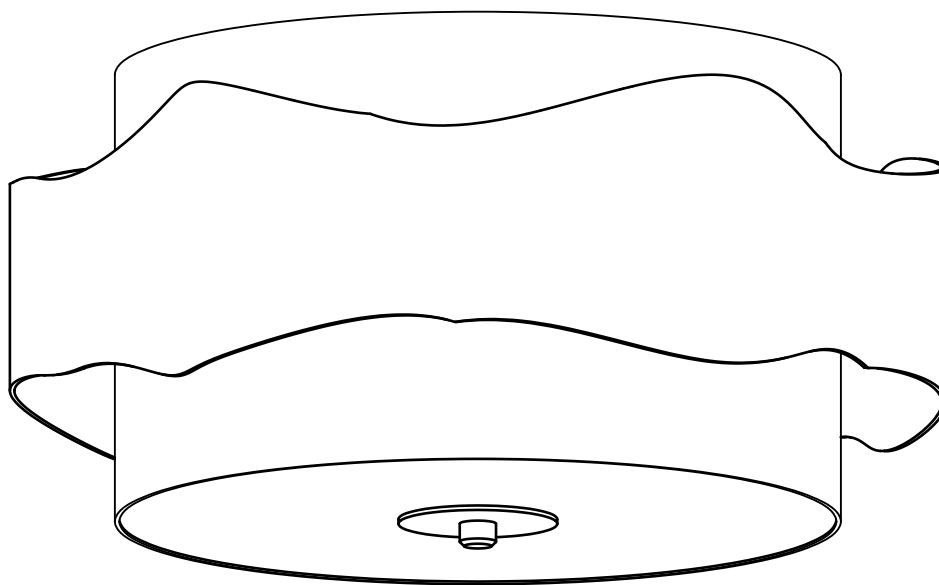

PRODUCT NAME: FLOW

ITEM NUMBER: 38390BZGTGLD

Please consult your electrician for hanging fixture and wiring.



E27 2X60W (No bulb included)

IMPORTANT: Turn off the power at the main fuse or circuit breaker box before starting installation.

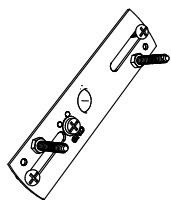

Mounting Strap (A)

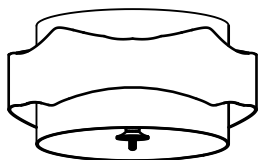

Body (B)



Nut (C)



Glass plate (D)

Locate all hardware & components before discarding packaging

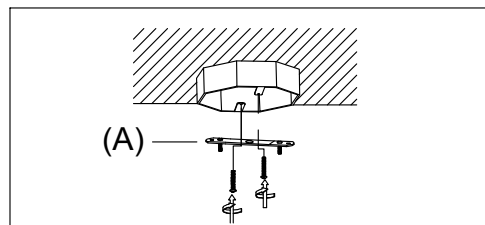
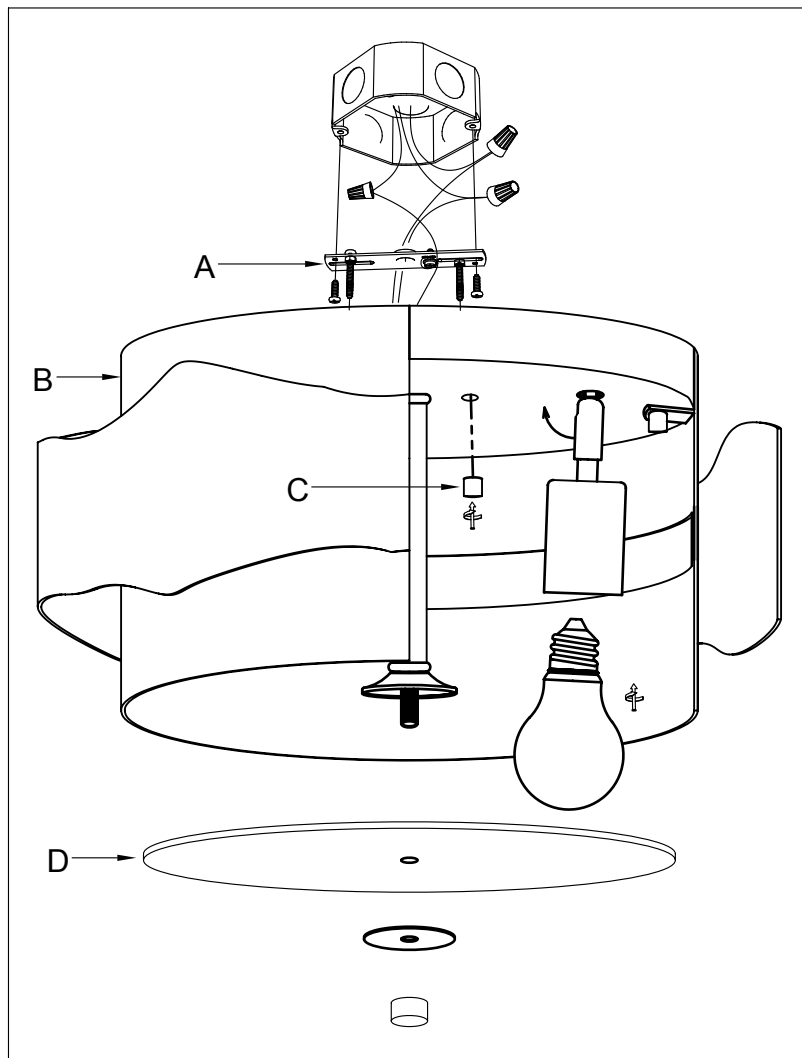

1.

Step.1: Remove mounting Strap (A) from fixture and install to electrical box.

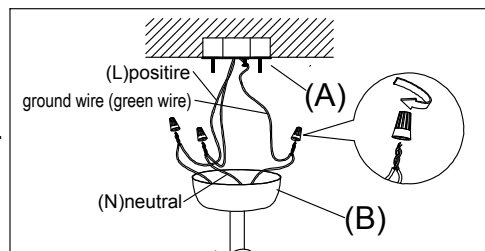

2.

Step.2: Wire fixture to wires in outlet box. Green wire is for Ground.

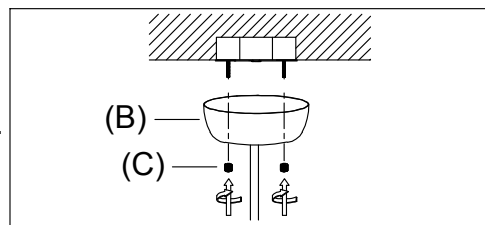

3.

Step.3: Install body (B) to Mounting Strap (A) and tighten nut (C) on the ceiling plate to secure. Install light bulb. The glass plate (D) is installed in the lamp body.

Cleaning & Care:

Clean with soft cloth and a mild detergent.
Do not use abrasive cleaner.