

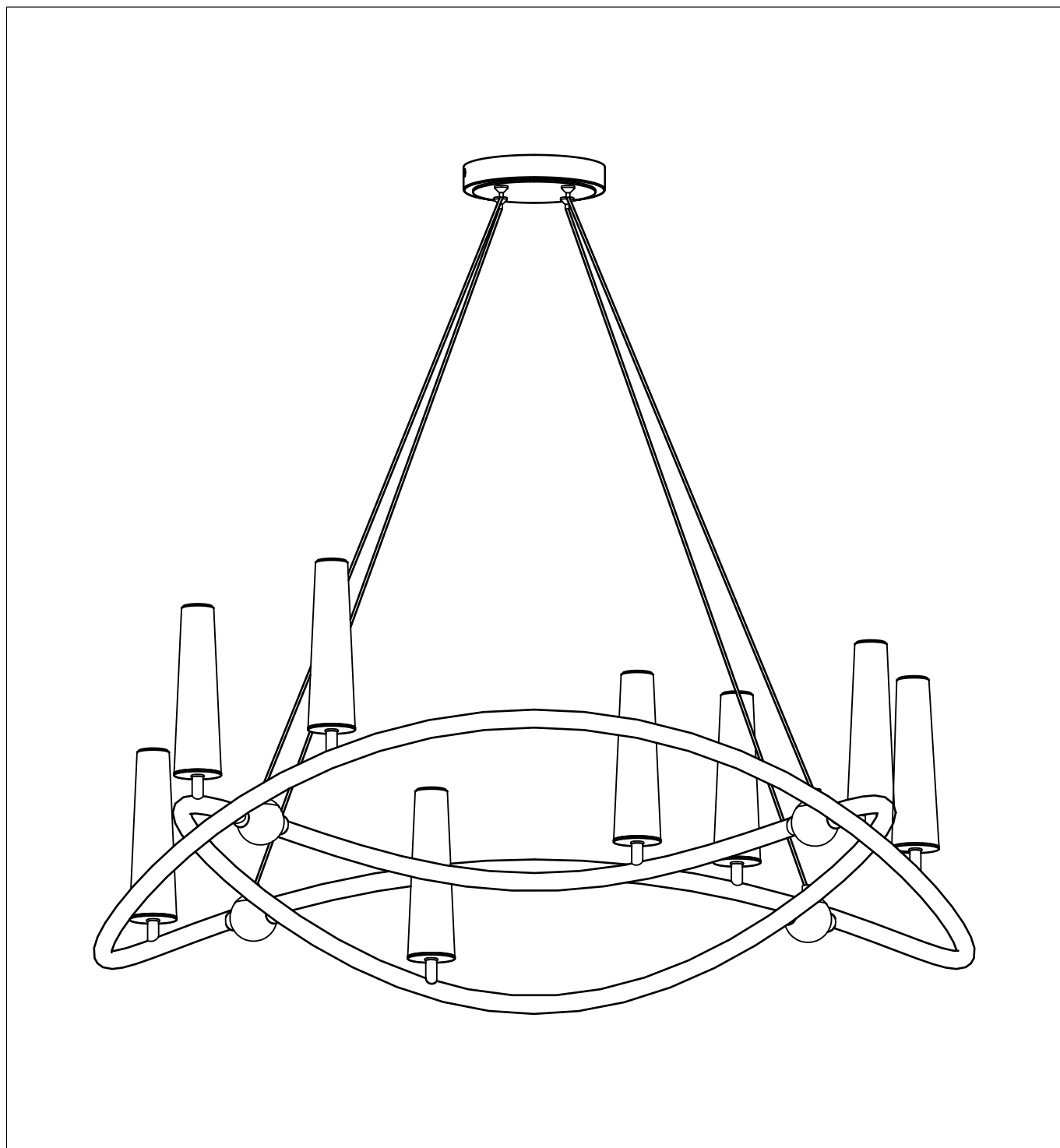

PRODUCT NAME: ENTWINE

ITEM NUMBER: 38497CLGS

Please consult your electrician for hanging fixture and wiring.



G9 8X40W (Bulb included)

IMPORTANT: Turn off the power at the main fuse or circuit breaker box before starting installation.

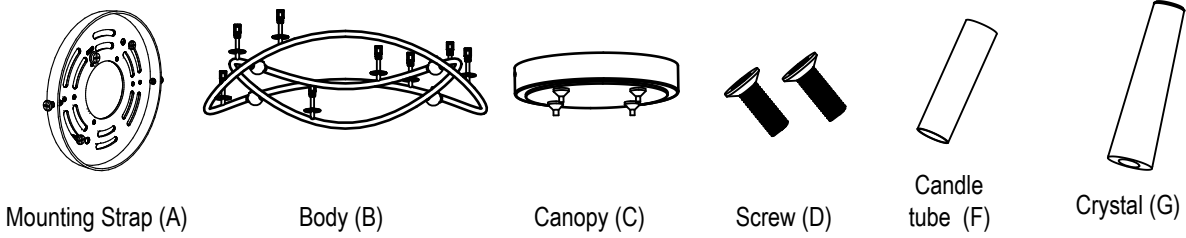

Locate all hardware & components before discarding packaging

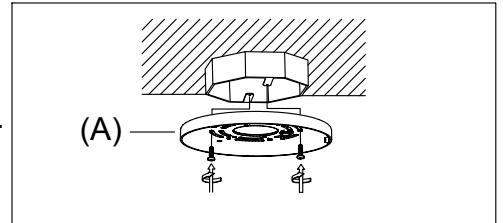
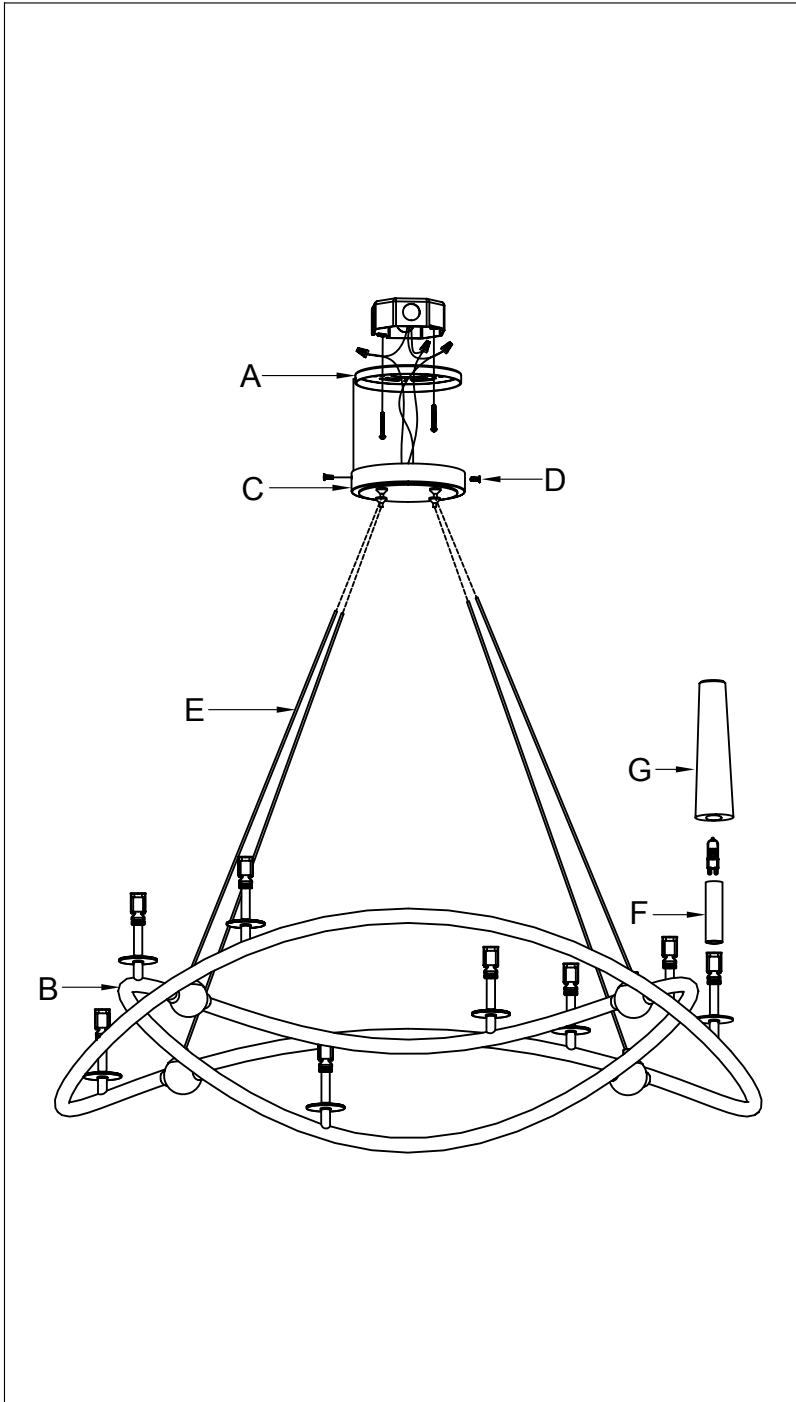

Step.1: Remove mounting Strap (A) from fixture and install to electrical box.

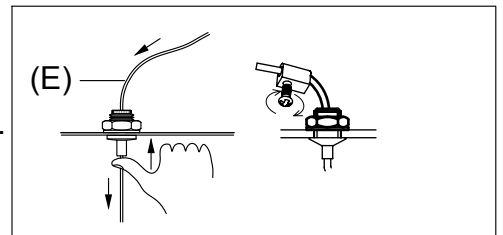

Step.2: Press the wire restraint to adjust the desired length of cable. Secure the cables.

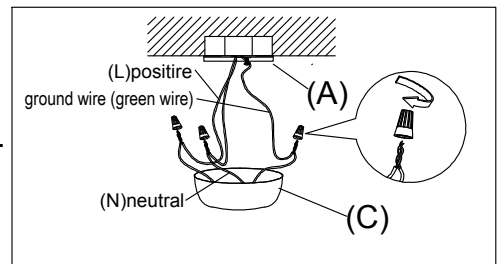

Step.3: Wire fixture to wires in outlet box. Green wire is for Ground.

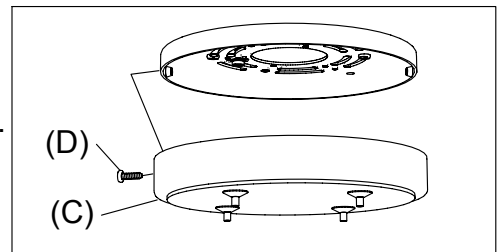

Step.4: Install body (B) to Mounting Strap (A) and tighten Screw (D) through the hole of canopy (C) on the Mounting Strap (A). Place the Candle tube (F) over the socket and Install light bulb. Install the crystal (G) on the lamp body

Cleaning & Care:
Clean with soft cloth and a mild detergent.
Do not use abrasive cleaner.