

Driver Installation:

Select desired location to mount drivers, which is not in contact with installation and away from oven and/or other source of intense heat and as close as possible to the lighting system to achieve the most efficient operation. (Drivers can be mounted vertically or horizontally).

After firmly mounting the drivers, select a listed connector (not furnished) appropriated to the type of electrical supply cable on site.

Remove cover and knockout from drivers and fasten connector to terminal cover and secure in place with connector.

If driver is being used in a damp or wet location, ensure open knockouts and/or connectors are waterproof.

See reverse for electrical Wiring Diagram

WARNING: This driver has a 2.3 Watt minimum load and minimum dimmable load. Do not use this driver with less than the required Load.

WARNING: Be sure that electricity to the wire you are working on is shut off, either the fuse removed or the circuit breaker off.

WARNING: Use of the other manufacturers components will void warranty, UL. and/or ETL listing, and create a potential safety hazard.

WARNING: Risk of electric shock, not submersible.

WARNING: Do Not energize electrical supply circuit to drivers until all connections have been made and tested according to national electrical codes and all local electrical codes. If you are unclear on how to proceed, contact a qualified electrician

CAUTION: Risk of fire: 12V LED tape must not be used in a 24V system, and 24V LED tape must not be used in 12V system.

CAUTION: The location and number of drivers installed on residential circuit breakers may cause the breakers to trip when the lighting load is energized. If this occurs, replace the residential circuit breaker with a breaker rated for high in-rush current.

AC Input: 120V-270V/60Hz 1.2A Max
DC Output: 24V 2.5A
Minimum Dimming Load: 2.5 Watts
Maximum Wattage: 60 Watts
PF:> 0.55
Efficiency: >75%
Output Current: 0-2.5A
Maximum Output Power: 60 Watts
Dimming Down Ability: 5%

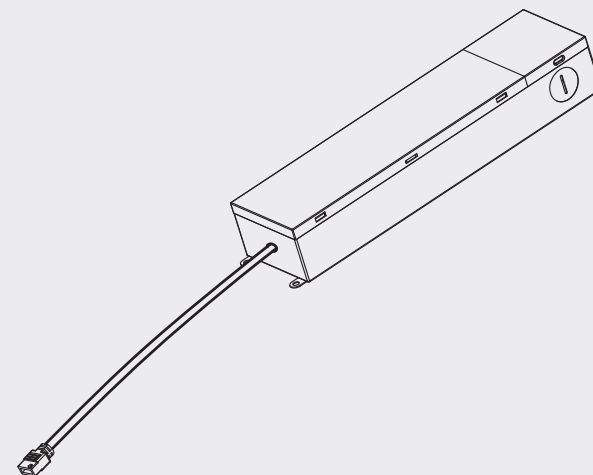

This is an electronic driver and should be used with a dimmer that is compatible with electronic loads

For a list of compatible dimmers please visit us at www.maximlighting.com or www.et2online.com.

Connect ground/common(green) wire from dimmer to yellow/green ground wire on the drivers

Connect hot/live(black) supply from dimmer to black wire on the drivers.

Connect wire neutral/negative(white) supply wire to white wire, by passing the dimmer.

Sample Wiring Diagram for MACL*
 *If not using MACL dimmer, see dimmer instructions for wiring diagrams specific to dimmer used with this application
 Single pole

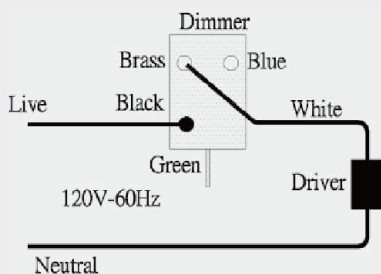

2 Year limited warranty

StarStrand™ LED Tape Lighting System components will be warranted for normal use for 2 years

while the original purchaser owns it. Normal use means residential non-commercial use for no more than 6 hours per day.

Maxim Lighting and/or ET2 Contemporary Lighting will, at its election, repair, replace or make appropriate adjustment where Maxim Lighting and/or ET2 Contemporary Lighting inspection discloses any such defects occurring in normal usage within two (2) years after date of shipment.

Maxim Lighting and/or ET2 Contemporary Lighting is not responsible for removal or installation costs. This warranty is limited to the repair or replacement of the product only and that Maxim

Lighting and/or ET2 Contemporary Lighting is not responsible for any labor incurred. Use of incorrect installation methods will void the warranty.

To obtain warranty service contact Maxim Lighting and/or ET2 Contemporary Lighting either through your Dealer, Contractor or E-tailer, or by writing Maxim Lighting International, Attn:

Customer Service Department, 253 North Vineland Avenue, City of Industry, CA 95746, USA, or by calling 1-800-486-2946 from within the USA and 1-626-956-4200 outside of the USA.

DISCLAIMER OF IMPLIED WARRANTY IMPLIED WARRANTIES INCLUDING THAT OF MERCHANTABILITY AND FITNESS FOR A PARTICULAR PURPOSE ARE EXPRESSLY LIMITED IN DURATION TO THE DURATION OF THIS WARRANTY. MAXIM LIGHTING AND/OR ET2 CONTEMPORARY LIGHTING AND/OR SELLER DISCLAIMS ANY LIABILITY FOR SPECIAL, INCIDENTAL OR CONSEQUENTIAL DAMAGES. Some states/provinces do not allow limitations on how long an implied warranty lasts, or the exclusion or limitation of special, incidental or consequential damages, so these limitations and exclusions may not apply to you.

This warranty gives you specific legal rights. You may also have other rights which vary from state/province to state/province. Maxim