

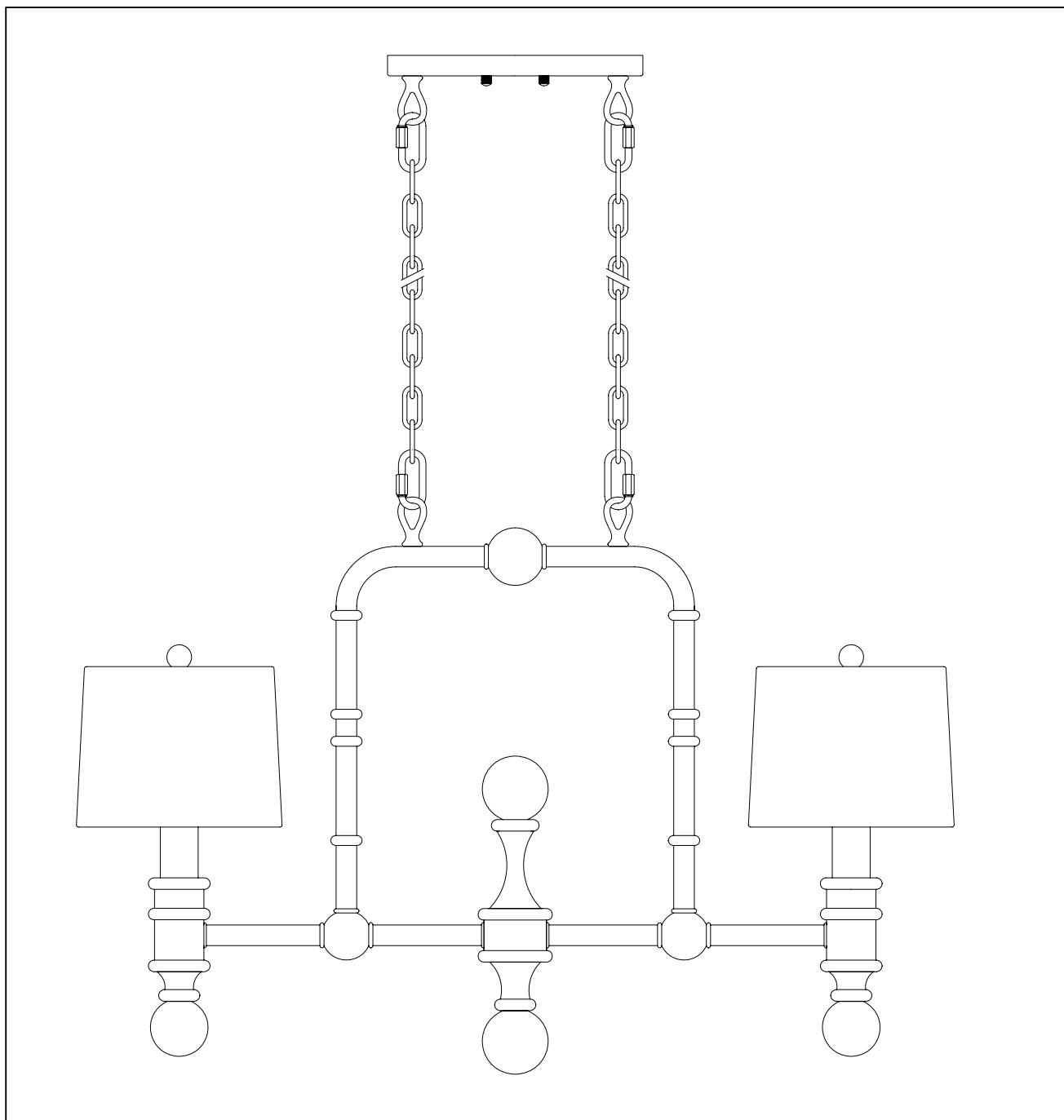

PRODUCT NAME: Saloon 2 Light Pendant  
ITEM NUMBER: 22422CLWBR

Please consult your electrician for hanging fixture and wiring.



**Bulb(not included) E26 2 x MAX 60W**

**IMPORTANT: Turn off the power at the main fuse of circuit breaker box before starting installation**



Mounting Bracket

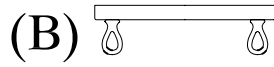

Canopy



Ball Nut(2pcs)

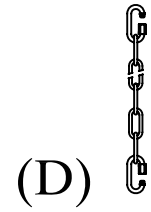

Metal Chain

Locate all hardware & components before discarding packaging

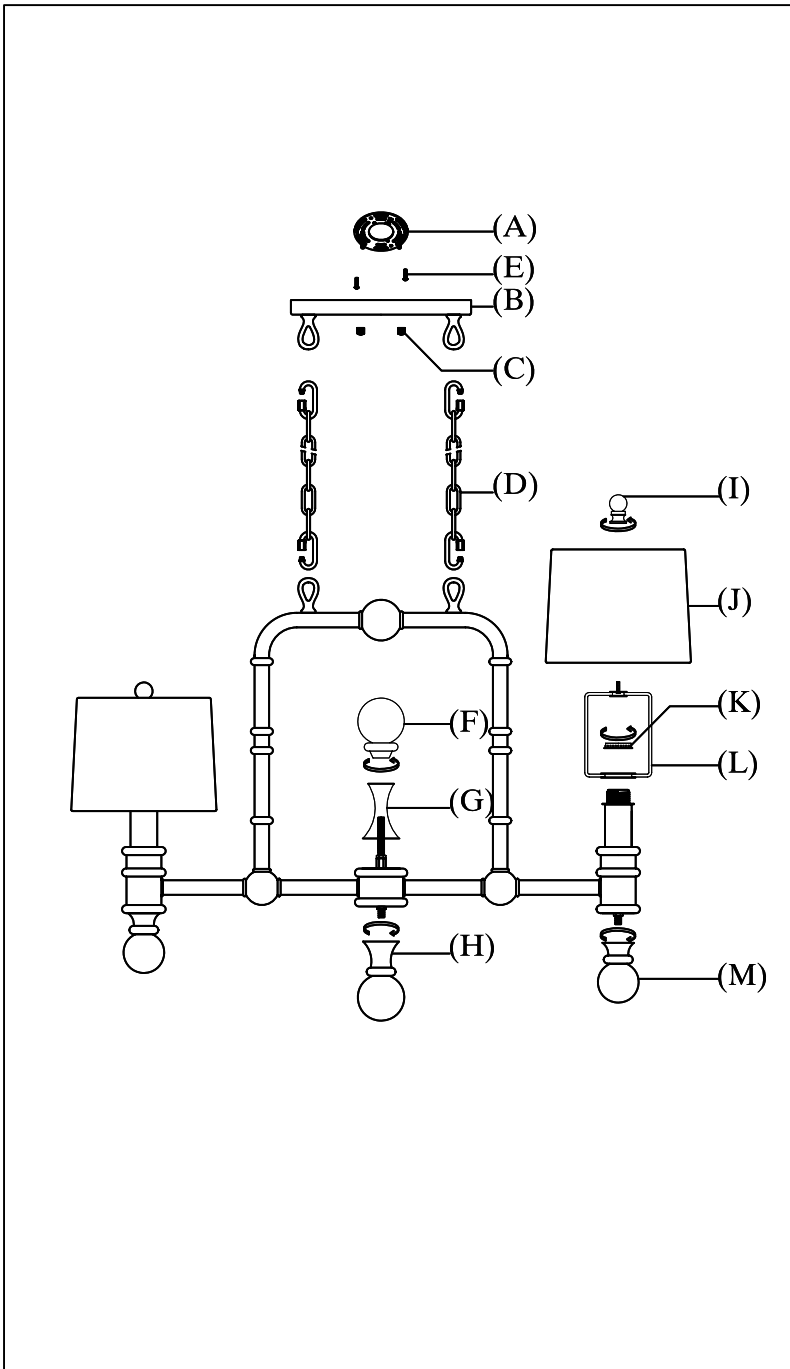

1.)

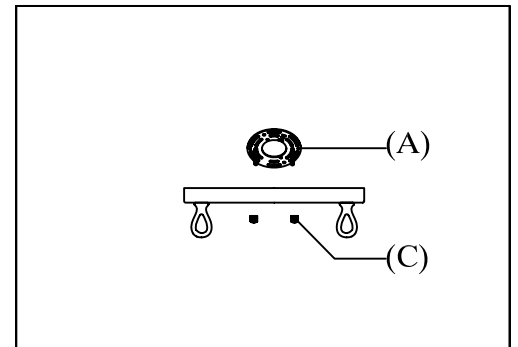

Step 1: Remove the mounting bracket (A) from the fixture by unthreading ball nuts (C).

2.)

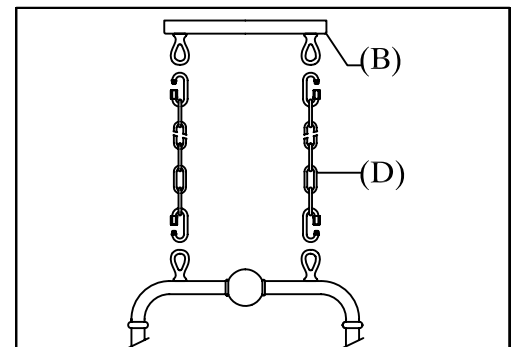

Step 2: Weave the fixture wire through every 3rd link in the chain and canopy. Connect the chain to the loop on fixture and loops on the canopy by using chain connector.

**Cleaning & Care:**

Clean with soft cloth and a mild detergent.  
Do not use abrasive cleaner.

**IMPORTANT: Turn off the power at the main fuse of circuit breaker box before starting installation**

(E)   
Screws(2pcs)

(F)   
Crystal Ball(1pc)

(G)   
Decorative Sleeve

(H)   
Crystal Finial(1pc)

Locate all hardware & components before discarding packaging

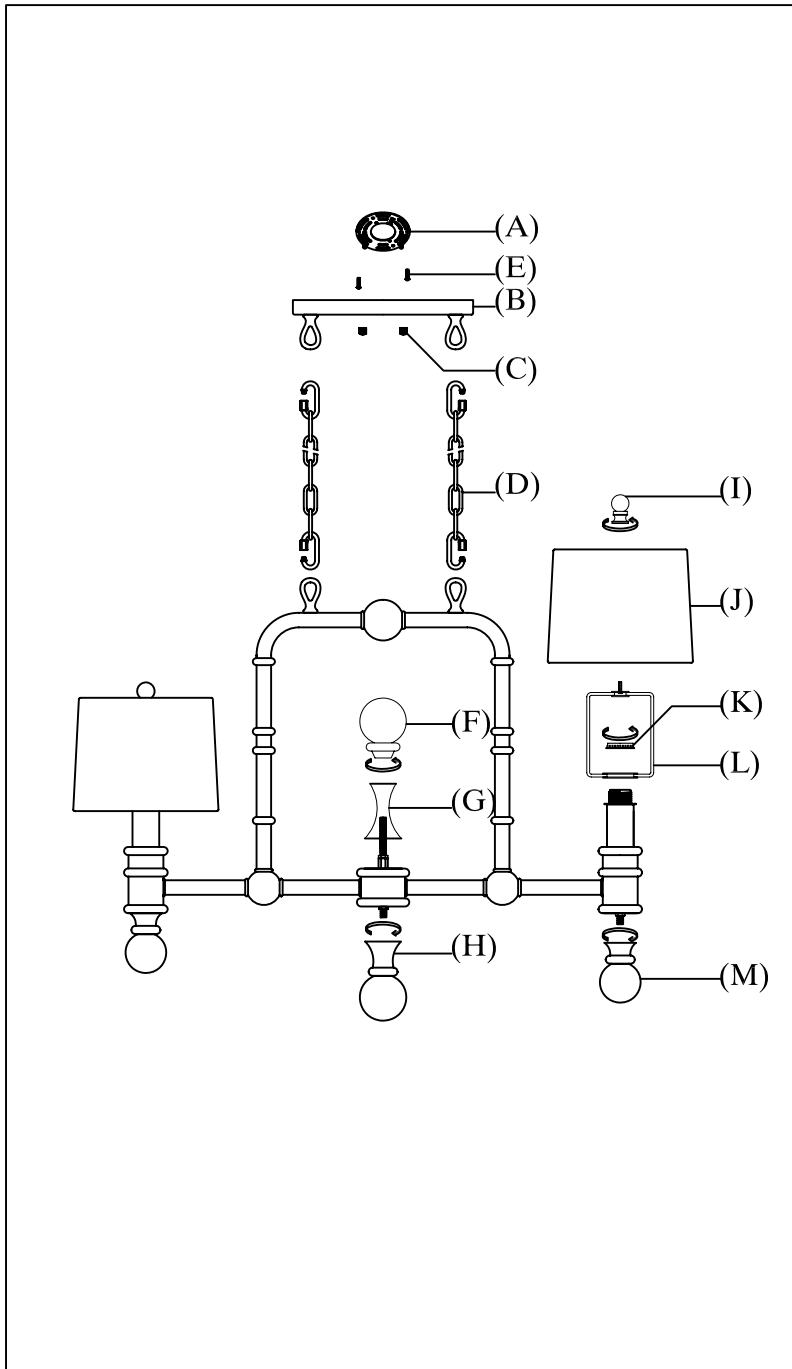

3.)

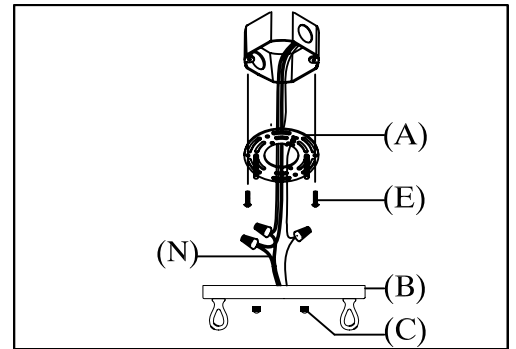

Step3: Attach the mounting bracket (A) to the outlet box by using two mounting screws (B). Make wire connections using wire nuts (N), and attach the fixture grounding wire to the mounting strap with the green grounding screws. Attach the canopy to the mounting bracket and secure it with two ball nuts (C).

4.)

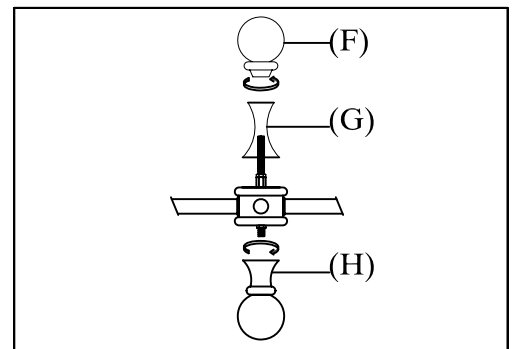

Step4: Run the decorative sleeve (G) over the thread and secure it with crystal finial (F). Finally, attach crystal (H) to the bottom of the fixture.

**Cleaning & Care:**

Clean with soft cloth and a mild detergent.  
Do not use abrasive cleaner.

**IMPORTANT: Turn off the power at the main fuse of circuit breaker box before starting installation**

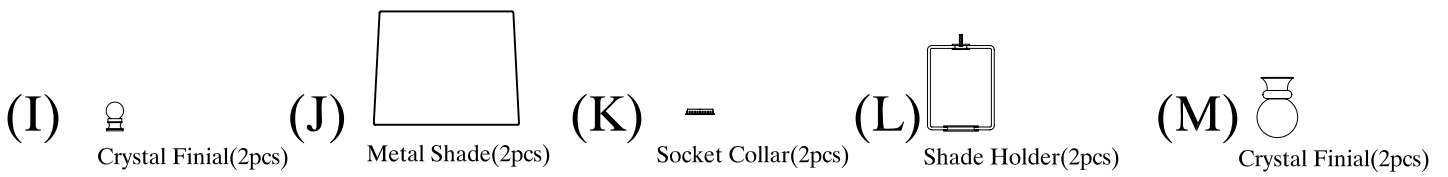

Locate all hardware & components before discarding packaging

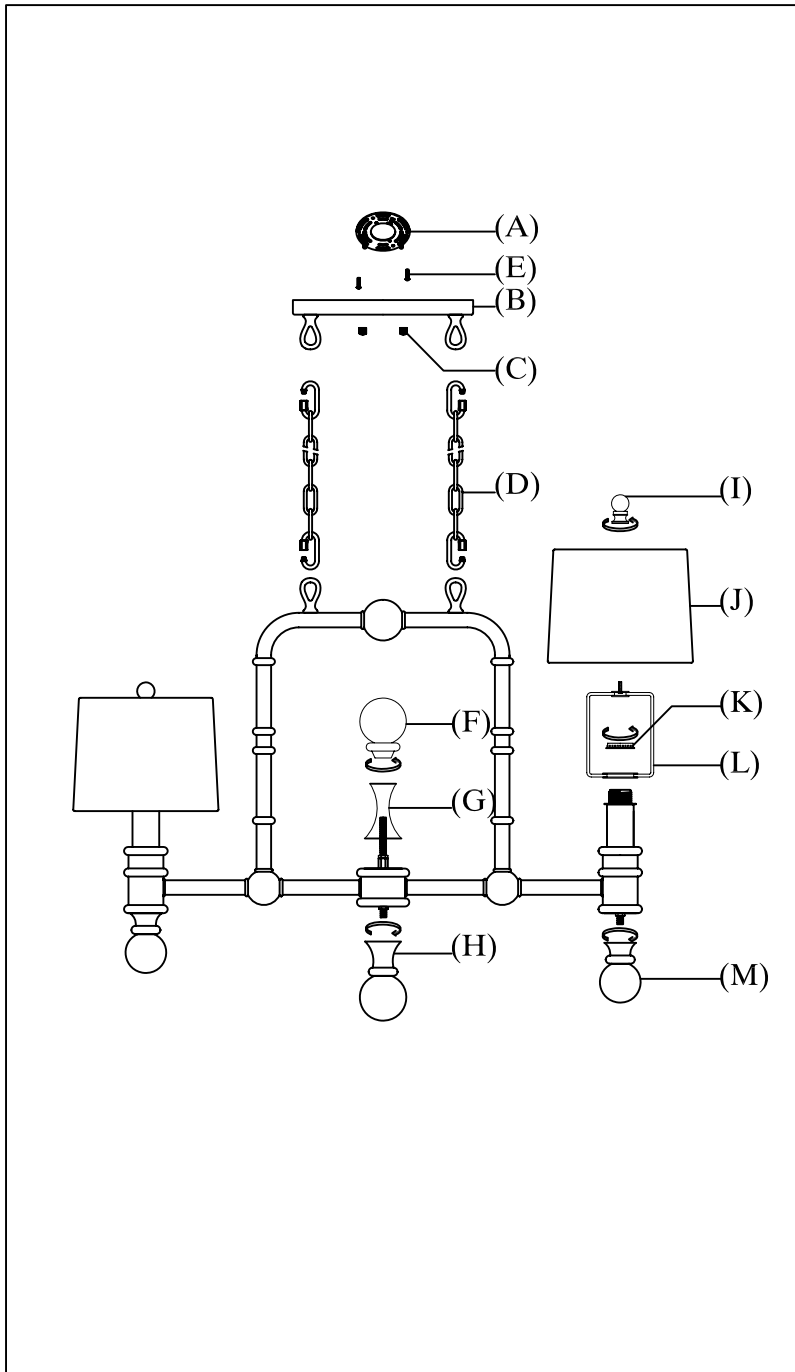

5.)

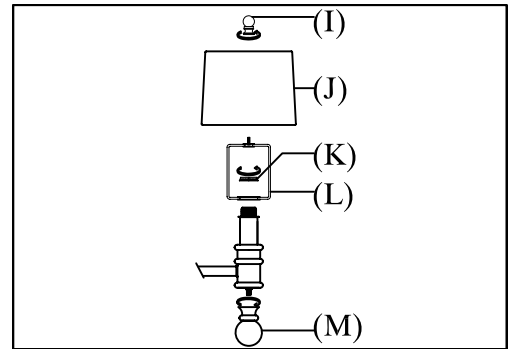

Step 5: Secure the shade harp (L) with the socket collar (K). Attach the metal shades and secure them with crystal finial (I). Finally, attach the crystal finials (M).

**Cleaning & Care:**

Clean with soft cloth and a mild detergent.  
Do not use abrasive cleaner.