

Please consult your electrician for hanging fixture and wiring.

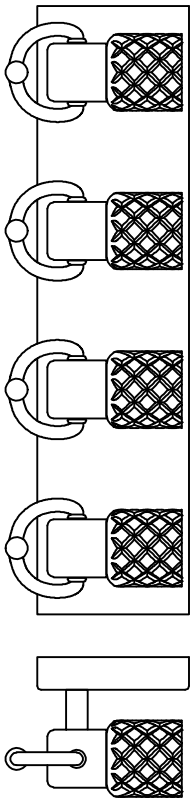

The fixture is designed to dim with a standard three forward phase dimmer. Dimming torch will vary by dimmer. The above belongs in box with recommended drivers.

Below is a list of recommended dimmers:

- Lutron MACE-153M
- Lutron DVL-153P
- Lutron SCI-153P
- Leyton TP/L06-10Z
- Leyton 6674-POW

Due to furnish current wattage should not exceed 150 watts of product a 600 watt dimmer.

WARNING: WIRES NEED TO BE CONNECTED TO DRIVER FOUND IN CANOPY AND SHOULD NOT CONNECT DIRECTLY TO POWER SOURCE OR A SHORT MIGHT OCCUR.

4*2.8W LED

IMPORTANT: Turn off the power at the main fuse or circuit breaker box before starting installation.

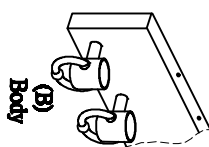
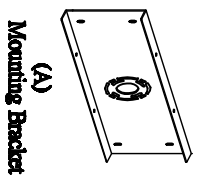

Locate all hardware & components before discarding packaging

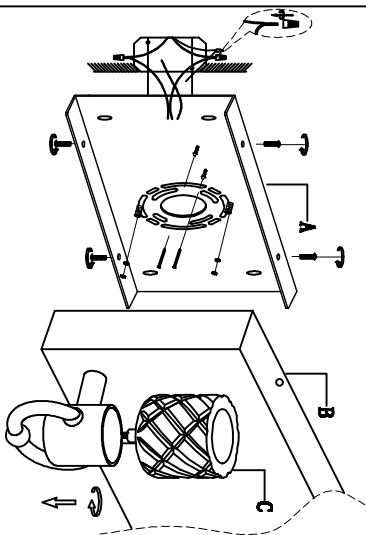
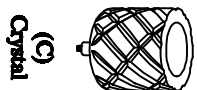

1.)

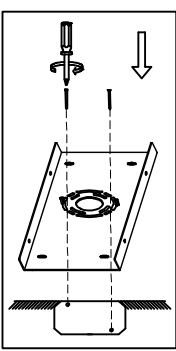

Step 1: Remove mounting bracket (A) from fixture and install to electrical box.

2.)

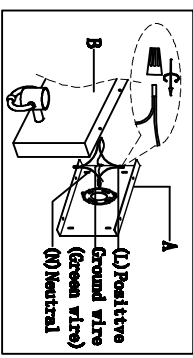

Step 2: Wire fixture to wires in outlet box. Green wire is for Ground.

3.)

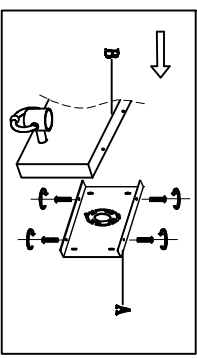

Step 3: Install Body(B) to Mounting Bracket (A) and tighten screws at the ends of the canopy to secure.

4.)

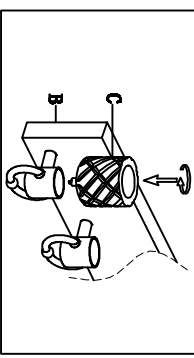

Step 4: screw the crystal (C) onto the lamp holder.

Cleaning & Care:

Clean with soft cloth and a mild detergent. Do not use abrasive cleaner.