

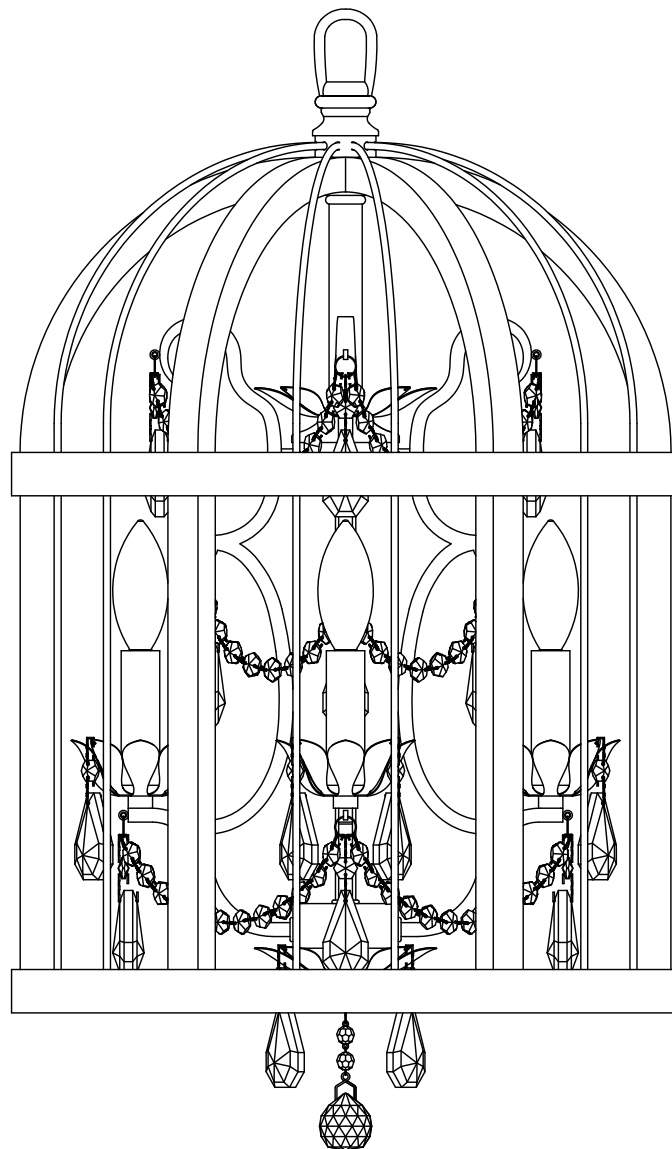

PRODUCT NAME: MIRANDA

ITEM NUMBER: 32512APBY

Please consult your electrician for hanging fixture and wiring.



E12 4X60W

IMPORTANT: Turn off the power at the main fuse or circuit breaker box before starting installation.

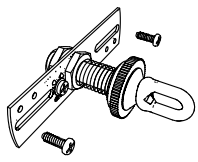

Mounting Strap (A)

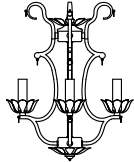

Body (B)



Frame (C)

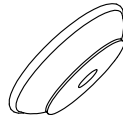

Canopy (D)



Chain (E)



Crystal (F)



Finial (G)



Bead String (H&J)

Locate all hardware & components before discarding packaging

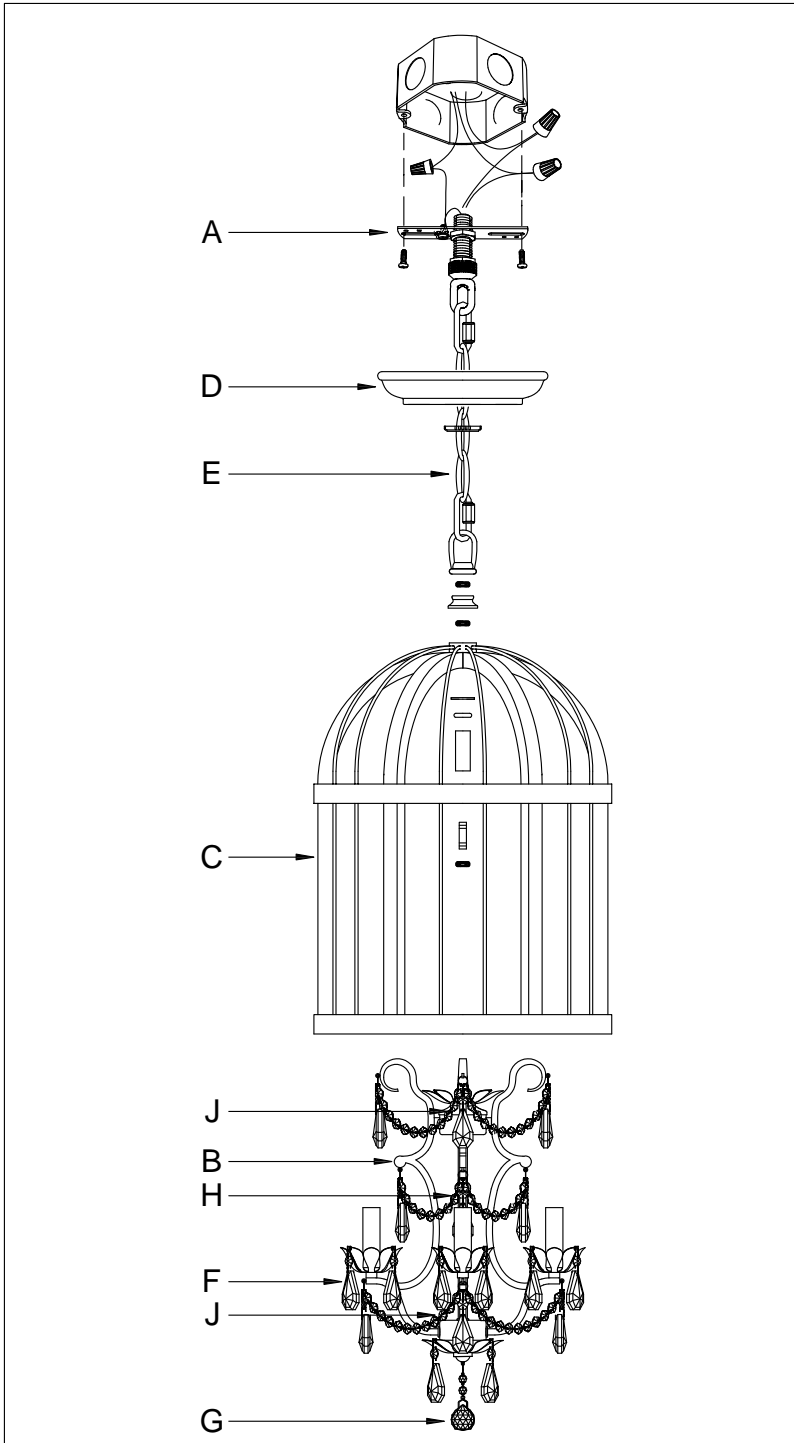

Cleaning & Care:
Clean with soft cloth and a mild detergent.
Do not use abrasive cleaner.

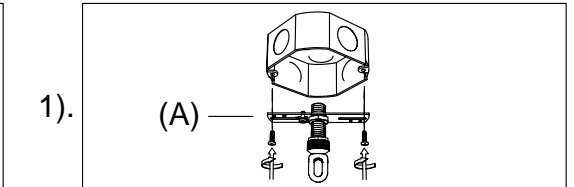

1). (A) —
Step.1: Remove mounting bracket (A) from fixture and install to electrical box.

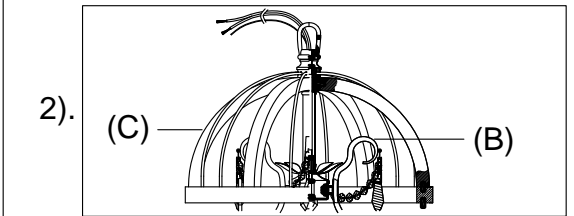

2). (C) — (B) —
Step.2: Place body (B) into frame (C) and secure with nut.

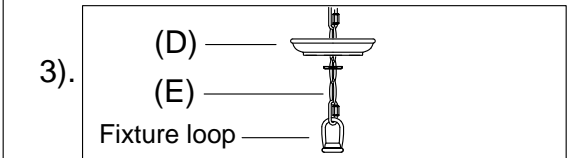

3). (D) — (E) —
Fixture loop —
Step.3: Install fixture loop. Connect chain (E) to fixture loop and canopy loop with key link. Thread fixture wire through the chain (E) into outlet box.

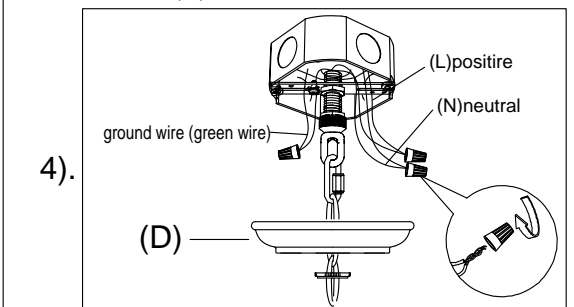

4). (D) —
Step.4: Wire fixture to wires in outlet box. Green wire is for Ground.

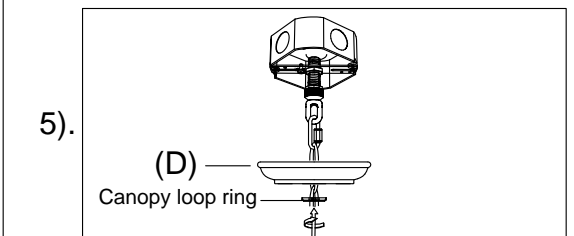

5). (D) —
Canopy loop ring —
Step.5: Raise Canopy (D) to ceiling and secure with canopy loop ring. Install light bulb. Hook crystal (F), finial (G) and bead string (H&J) on the body.