

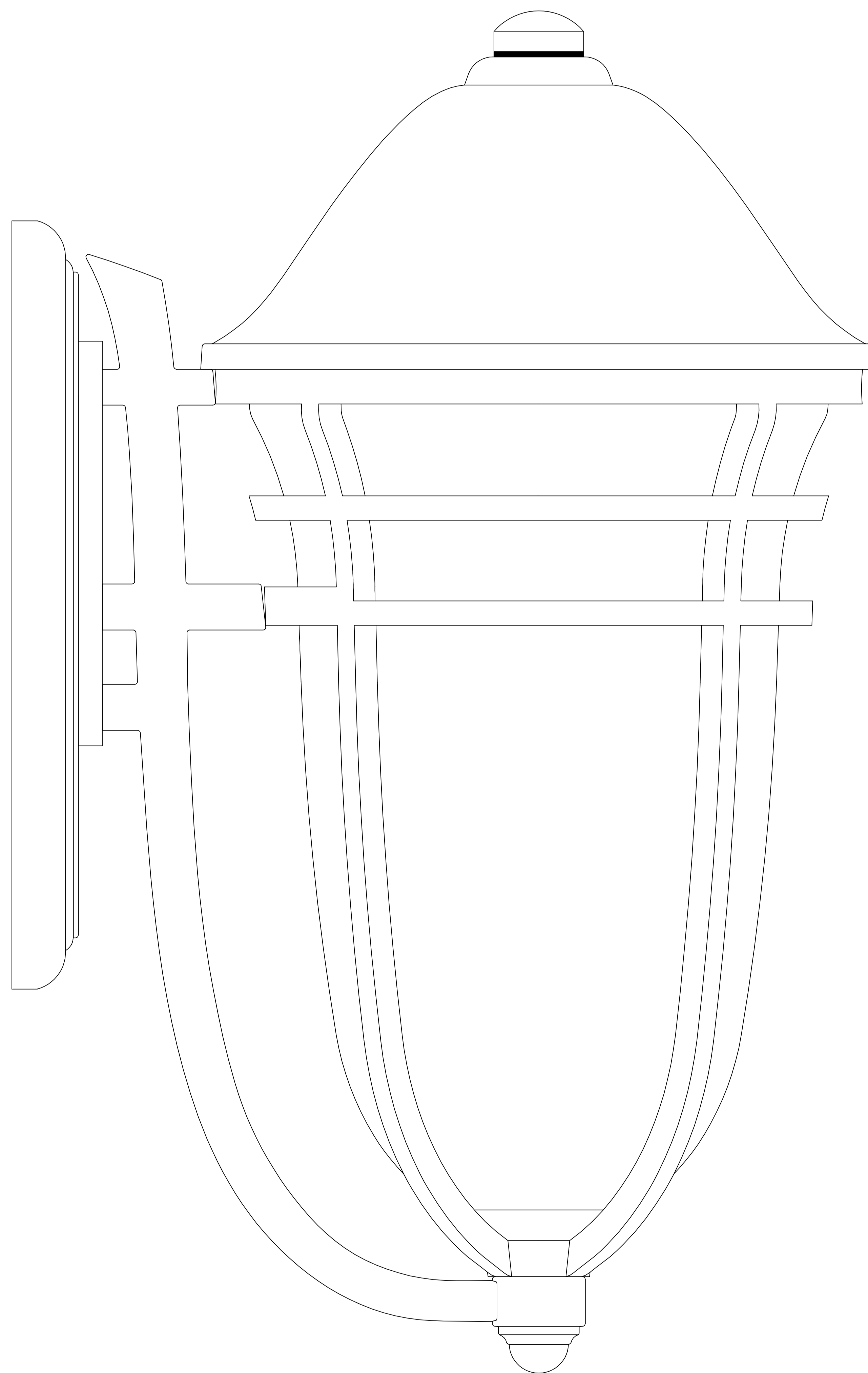

PRODUCT NAME: Westport
ITEM NUMBER: 34204 / 34205

Please consult your electrician for hanging fixture and wiring.



To prevent water intrusion, caulk around back-plate where fixture meets the wall using outdoor silicone sealant. Leave a small gap at the bottom to allow moisture to exit.

Bulb(not included): MB 1×60W



PRODUCT NAME: Westport
 ITEM NUMBER: 34204 / 34205

IMPORTANT: Turn off the power at the main fuse or circuit breaker box before starting installation.

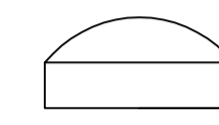
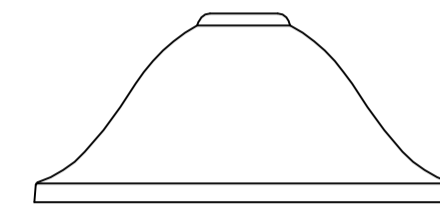
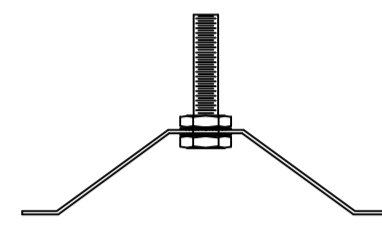
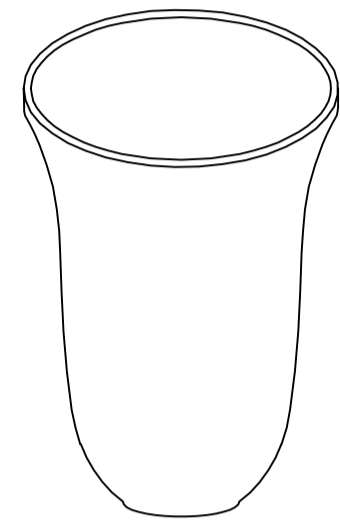
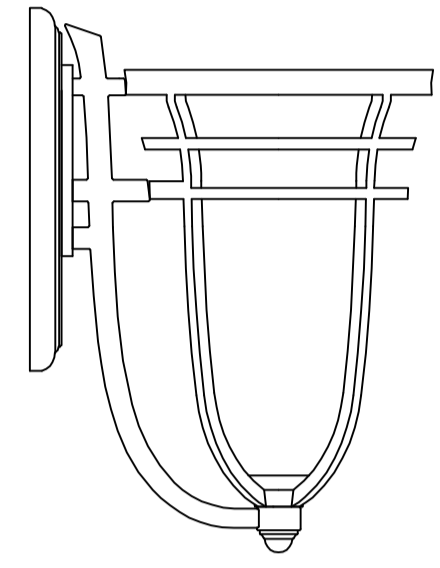
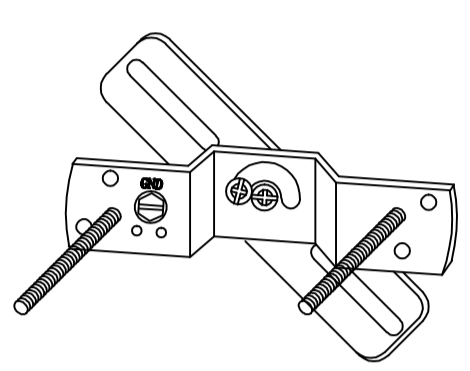

Bracket (A)

Fixture (B)

Glass (C)

Trestle (D)

Hood (E)

Finial (F)

Locate all hardware & components before discarding packaging

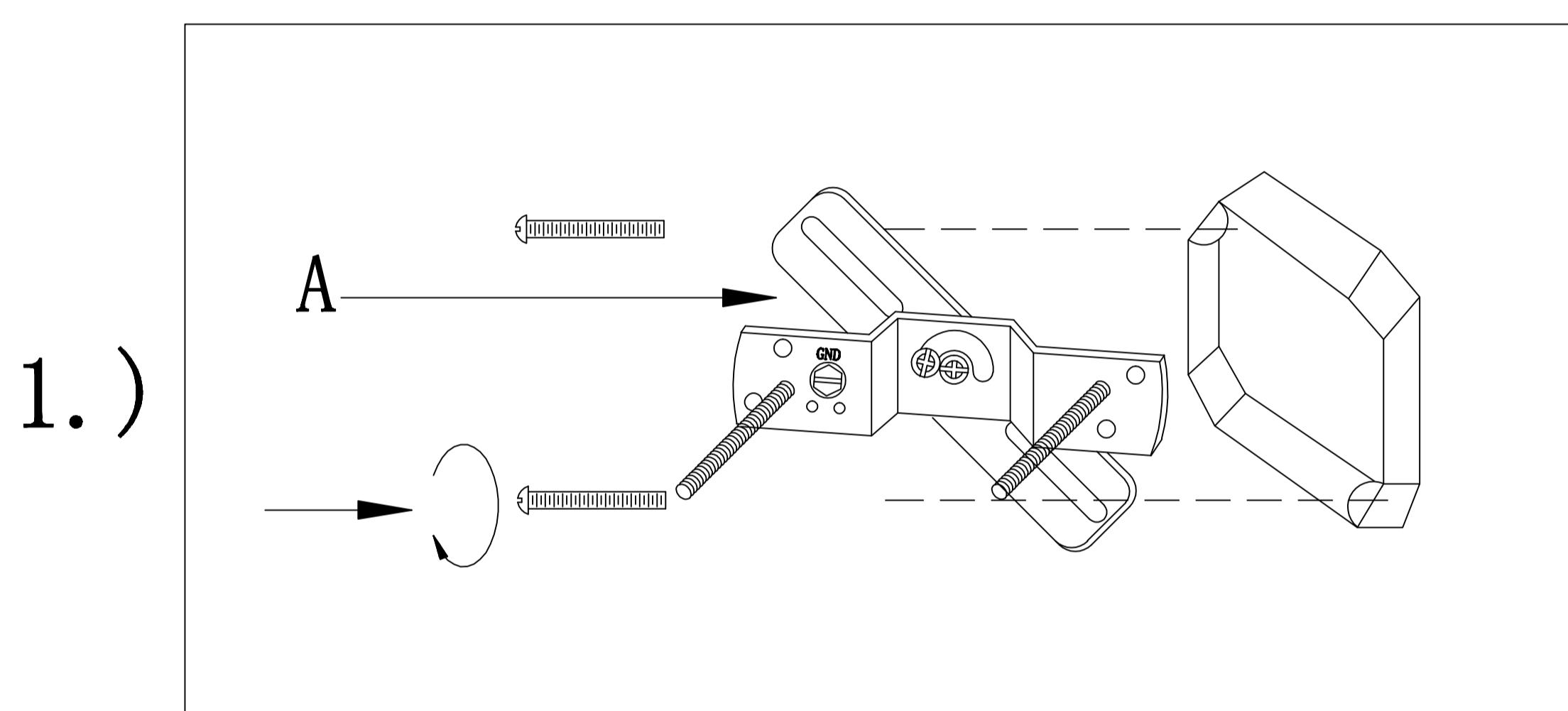

1.)

Step.1: Remove mounting bracket from fixture(B) and install to electrical box. then wire fixture to wires in outlet box. Copper wire is for Ground.

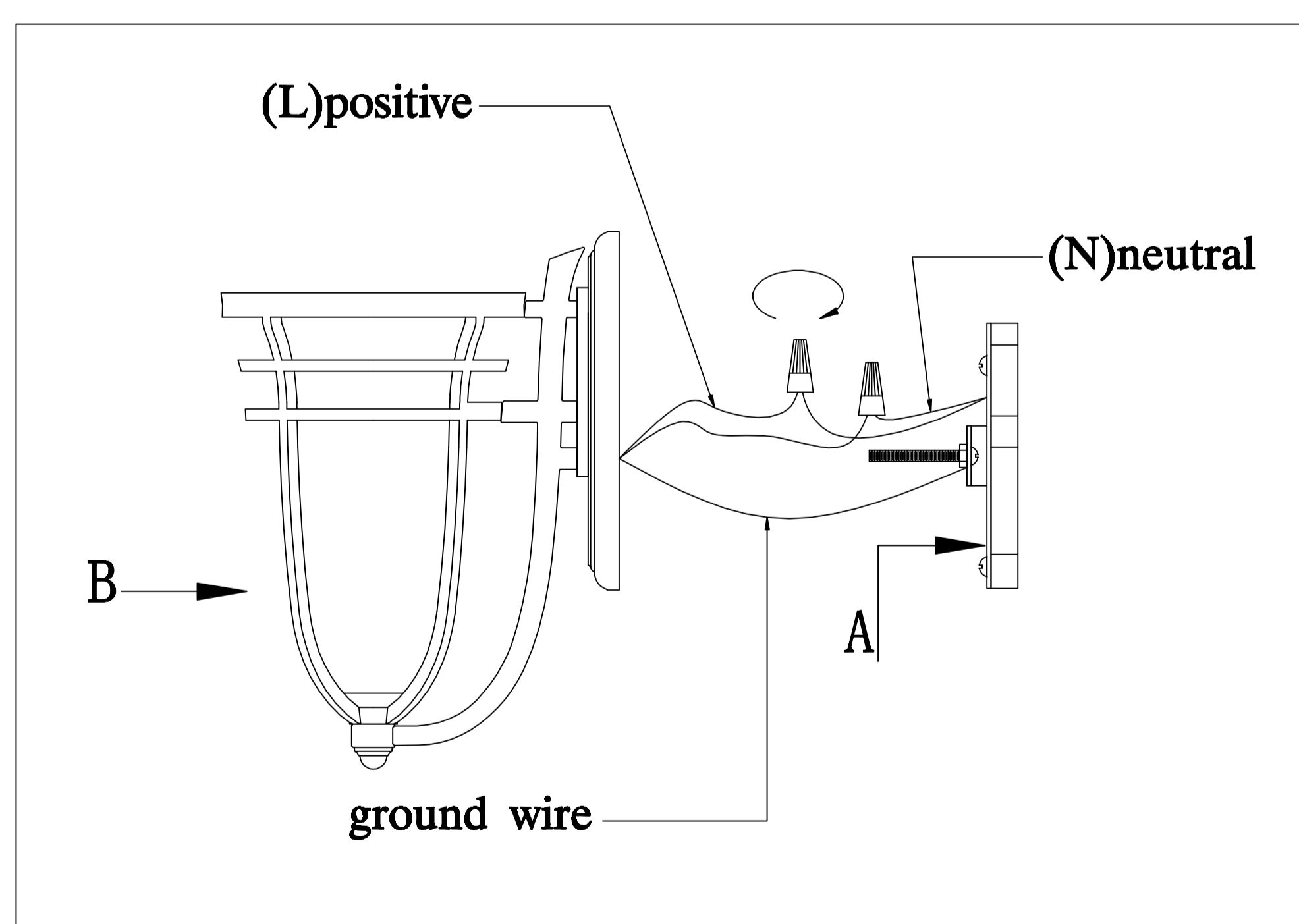

2.)

Step.2: Attach back plate to mounting bracket and tighten ball nuts so fixture meets wall. Caulk fixture where back plate meets the wall with silicone sealant.

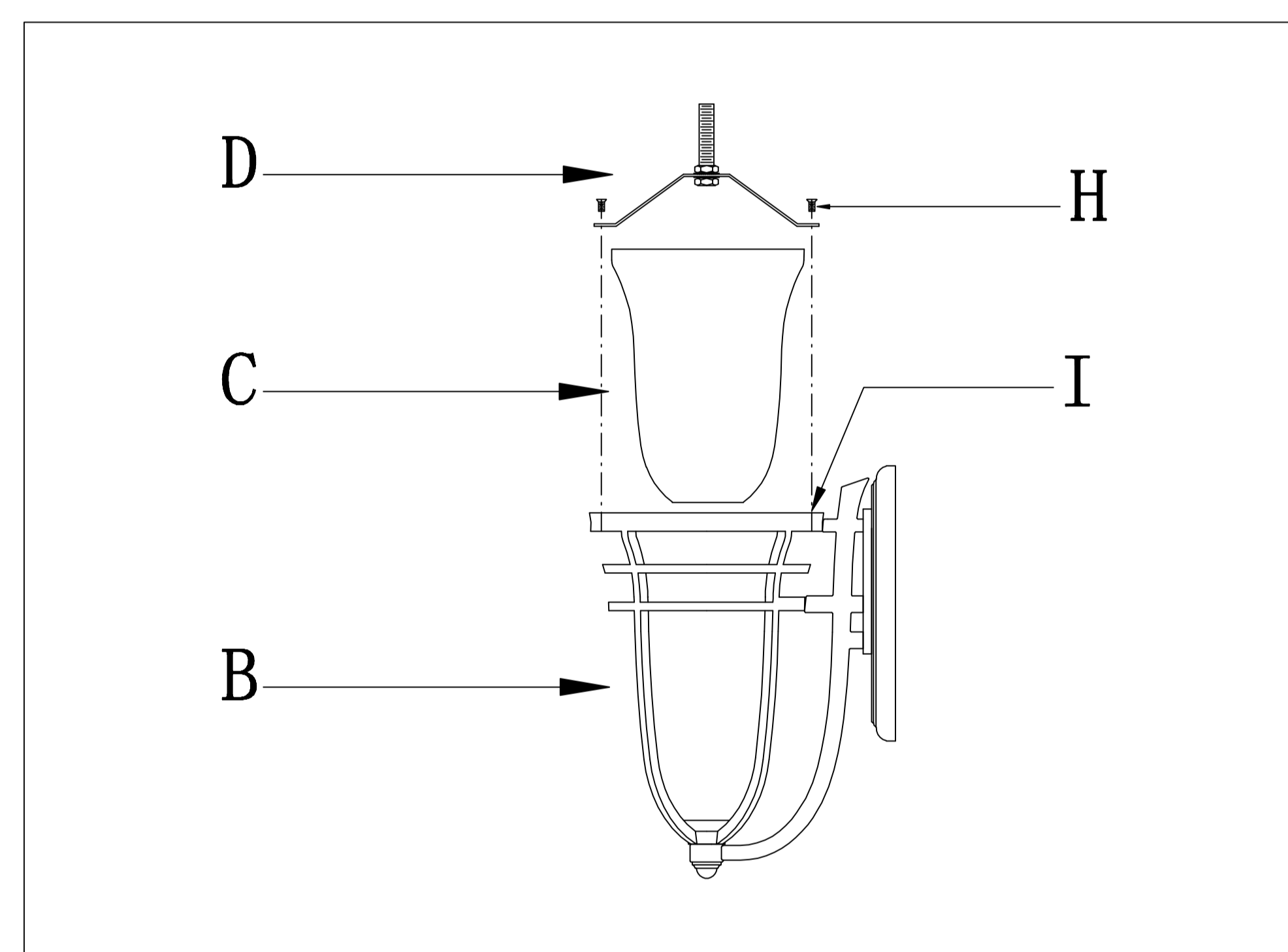

3.)

Step.3: Attach glass(C) and secure using trestle(D) to the fixture using screws(H) at point(I).

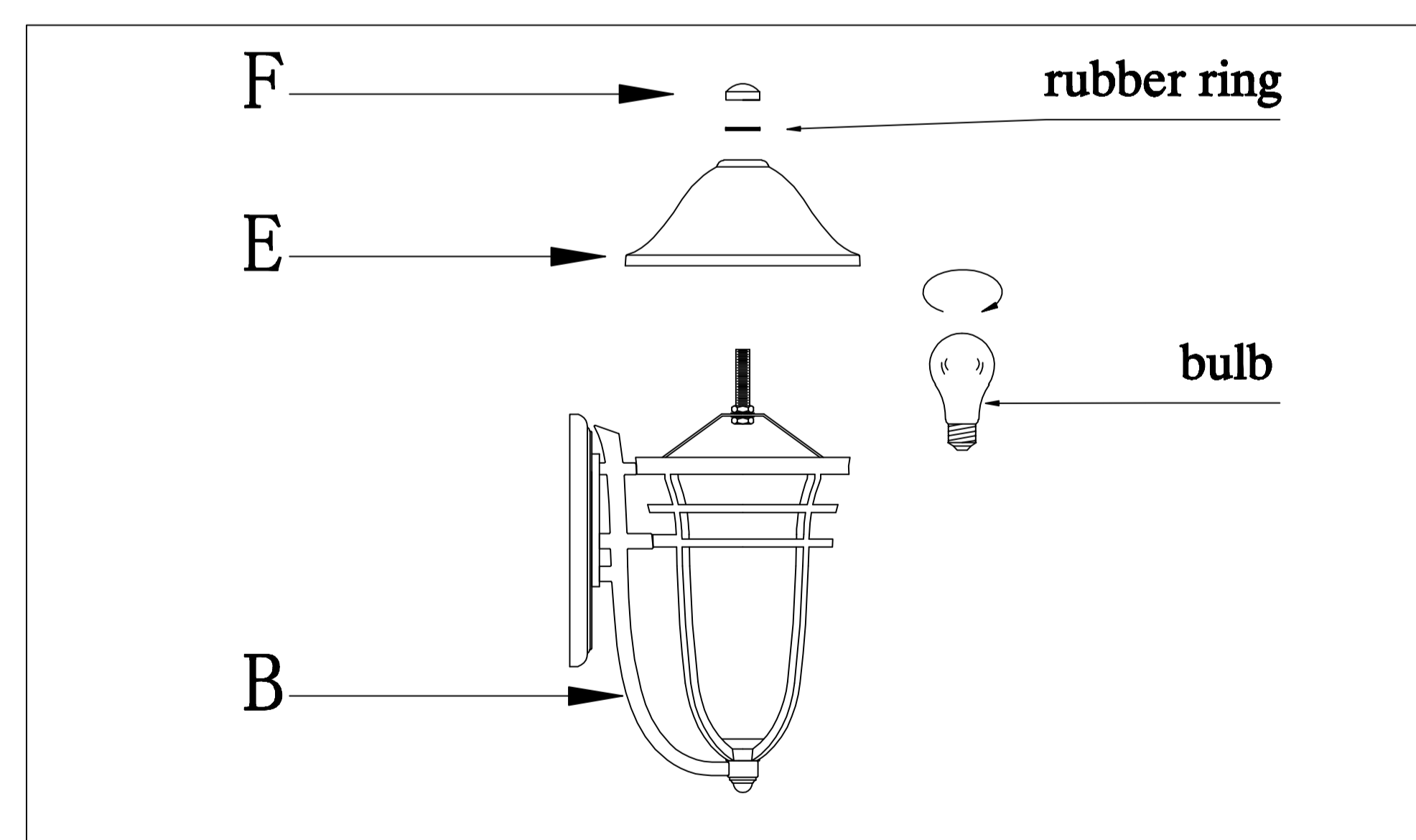

4.)

Step.4: Install MB bulb, attach hood(E) and finial(F) .

Cleaning & Care:
 Clean with soft cloth and a mild detergent.
 DO not use abrasive cleaner.