

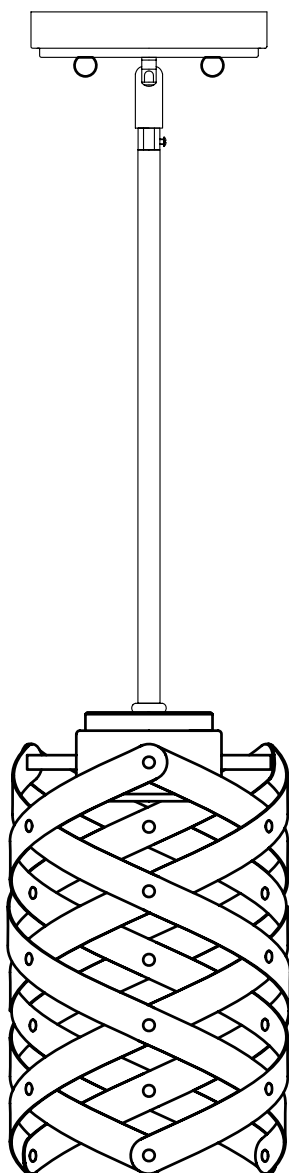

PRODUCT NAME: WEAVE

ITEM NUMBER: 35059BZGTGLD

Please consult your electrician for hanging fixture and wiring.



LED 1X11W (Bulb included)

**IMPORTANT: Turn off the power at the main fuse or circuit breaker box before starting installation.**

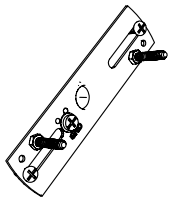

Mounting Strap (A)

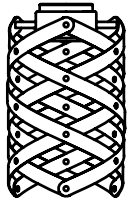

Body (B)

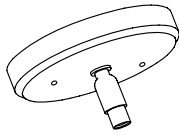

Canopy (C)

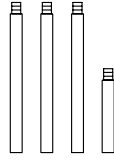

Rod (D)



Nut (E)

**Locate all hardware & components before discarding packaging**

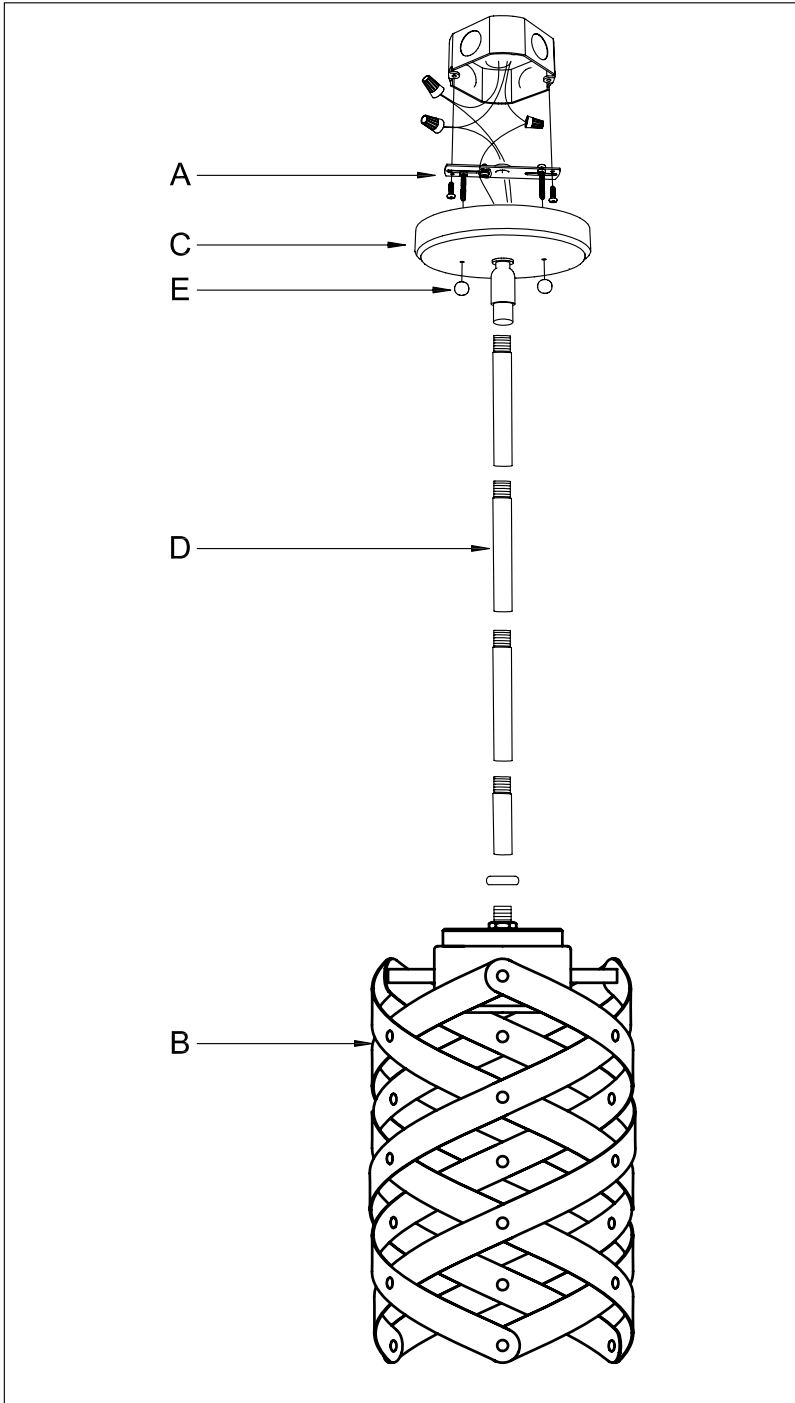

1).

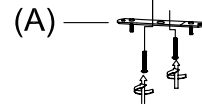

Step.1: Remove mounting bracket (A) from fixture and install to electrical box.

2).

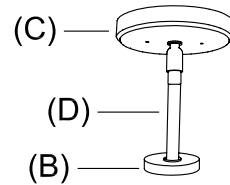

Step.2: Determine correct length of rod needed for hanging height. Screw the Rod (D) on the Body (B) and Canopy (C).

3).

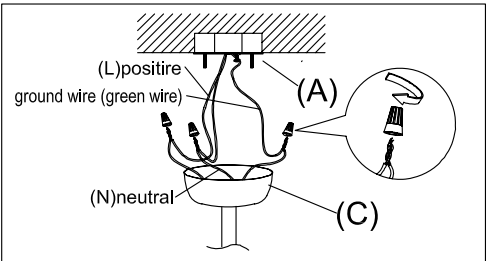

Step.3: Wire fixture to wires in outlet box. Green wire is fo Ground.

4).

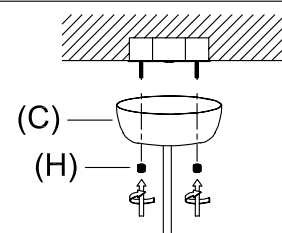

Step.4: Install body (B) to Mounting Strap (A) and tighten nut (E) on the canopy (C) to secure.

**Cleaning & Care:**

Clean with soft cloth and a mild detergent.  
Do not use abrasive cleaner.