

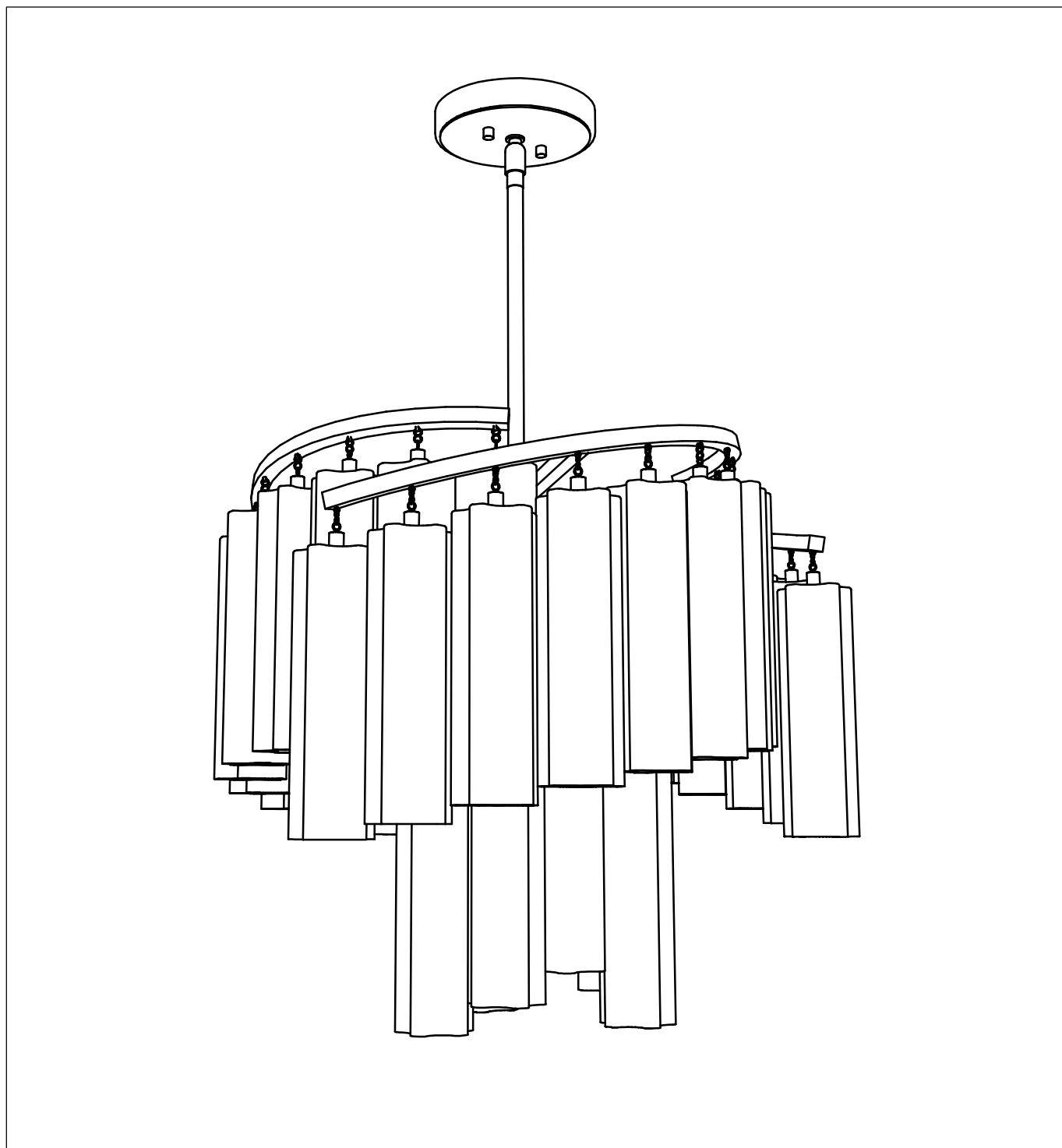

**PRODUCT NAME: VICTORIA**

**ITEM NUMBER: 39575WFLGS**

**Please consult your electrician for hanging fixture and wiring.**



**E27 4X60W  
E12 3X60W**

**MADE IN CHINA  
Page 1 of (2)**

**IMPORTANT: Turn off the power at the main fuse or circuit breaker box before starting installation.**

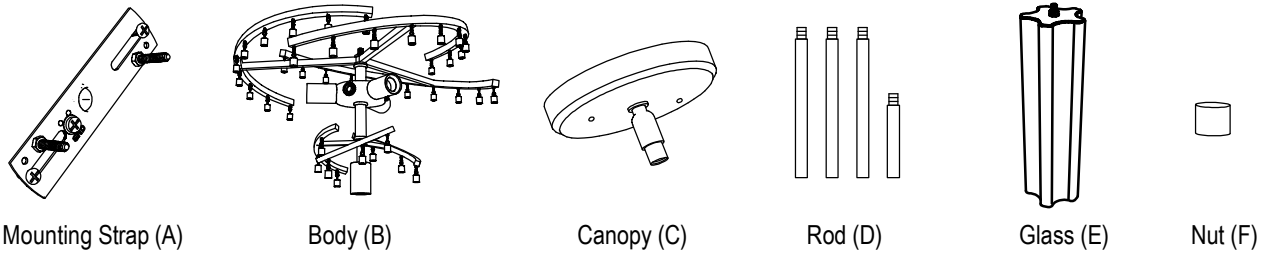

**Locate all hardware & components before discarding packaging**

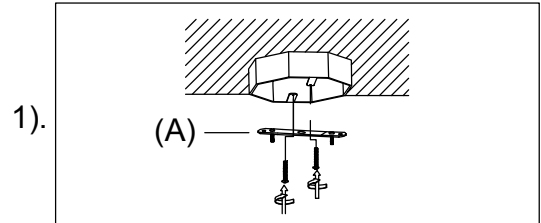
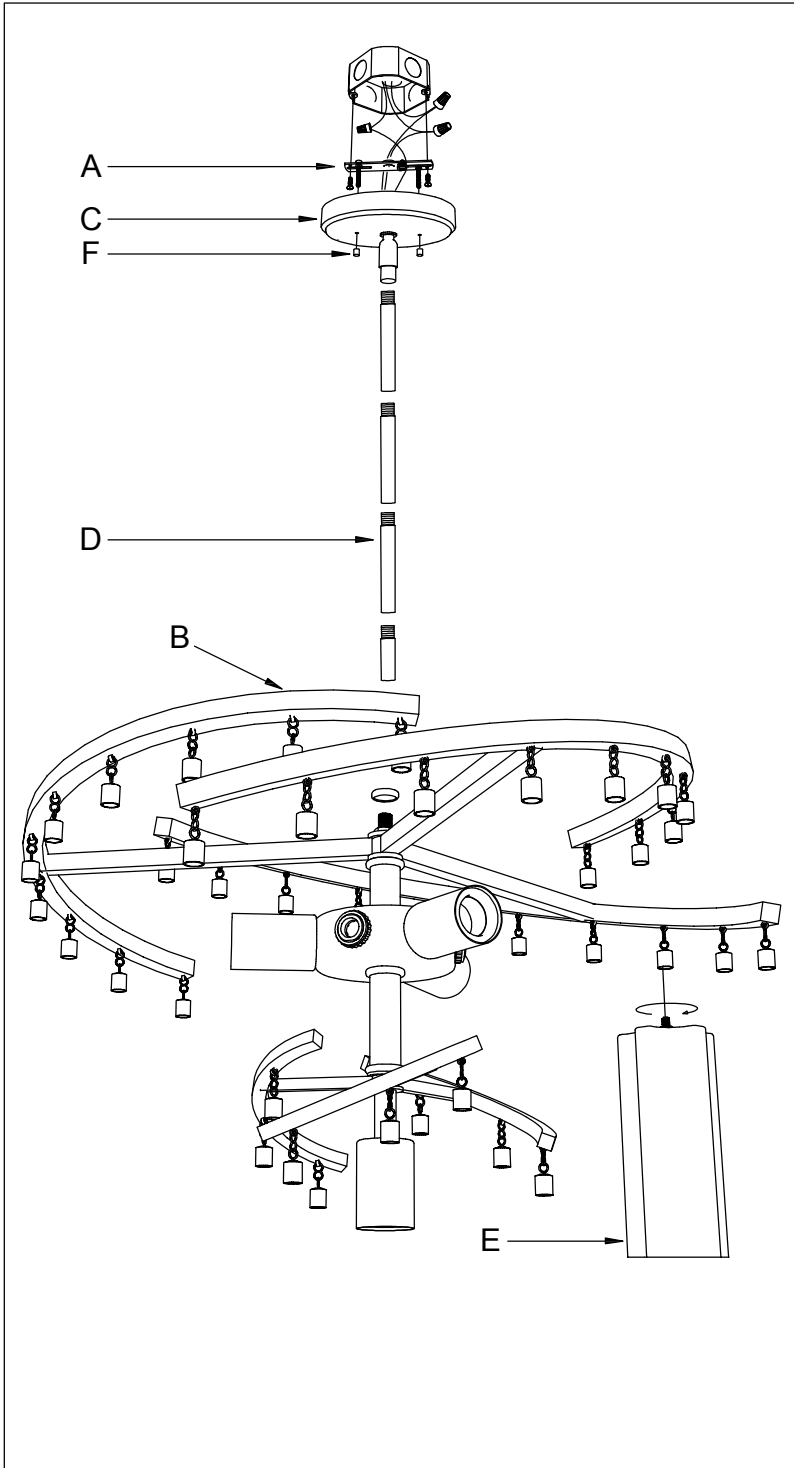

Step.1: Remove mounting bracket (A) from fixture and install to electrical box.

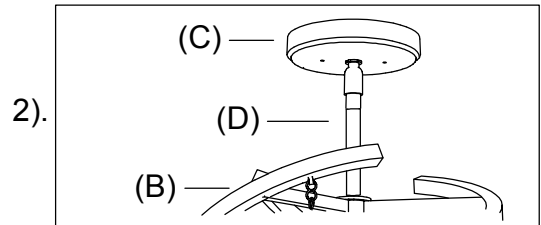

Step.2: Determine correct length of rod needed for hanging height. Screw the Rod (D) on the Body (B) and Canopy (C).

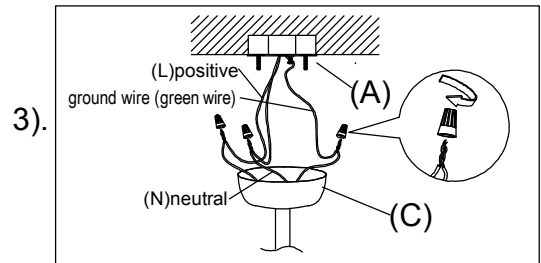

Step.3: Wire fixture to wires in outlet box. Green wire is for Ground.

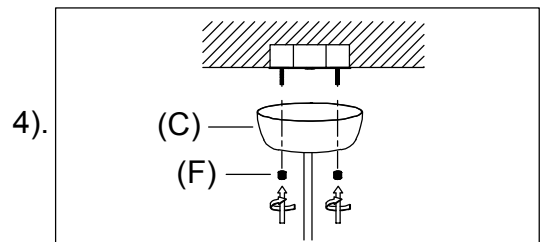

Step.4: Install body (B) to bracket (A) and tighten nut (F) on the canopy (C) to secure. Screw glass (E) to the coupling. Install light bulb.

**Cleaning & Care:**

Clean with soft cloth and a mild detergent.  
Do not use abrasive cleaner.