



Assembly Instruction For 39728RBPC

Disconnect power at breaker for outlet fixture is to be installed on.

1. Install mounting bracket to outlet box.
2. Wire fixture to outlet box wires. Bare copper wire is for ground.
3. Please refer to the Glass Installing Instruction provided in the glass packaging for steps to install the glass.

This fixture is supplied with long lasting LED lighting. Each LED module can be replaced if needed. Contact Maxim Lighting for replacement. It is recommended to use a Lutron CL dimmer if dimming is required.

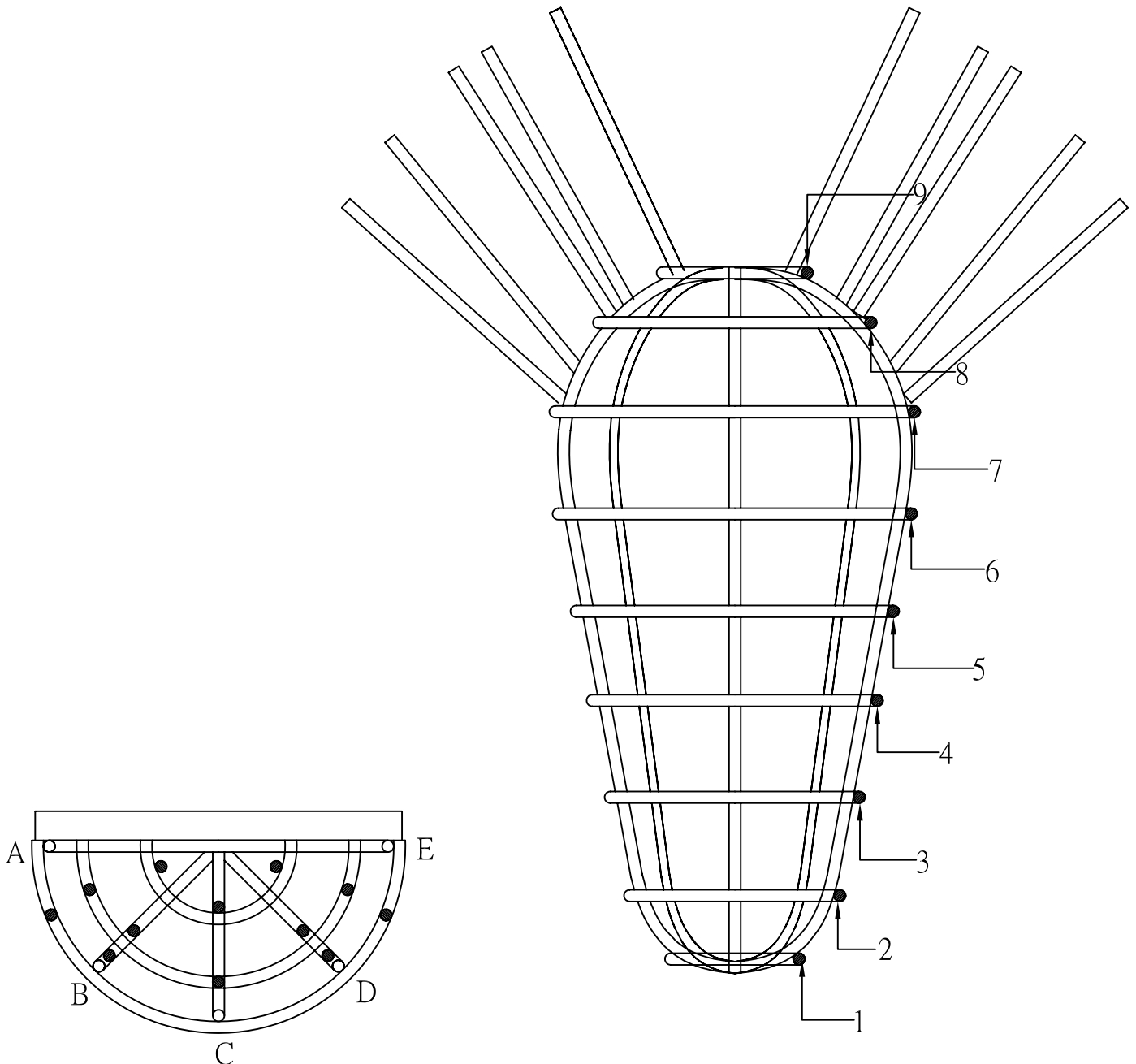

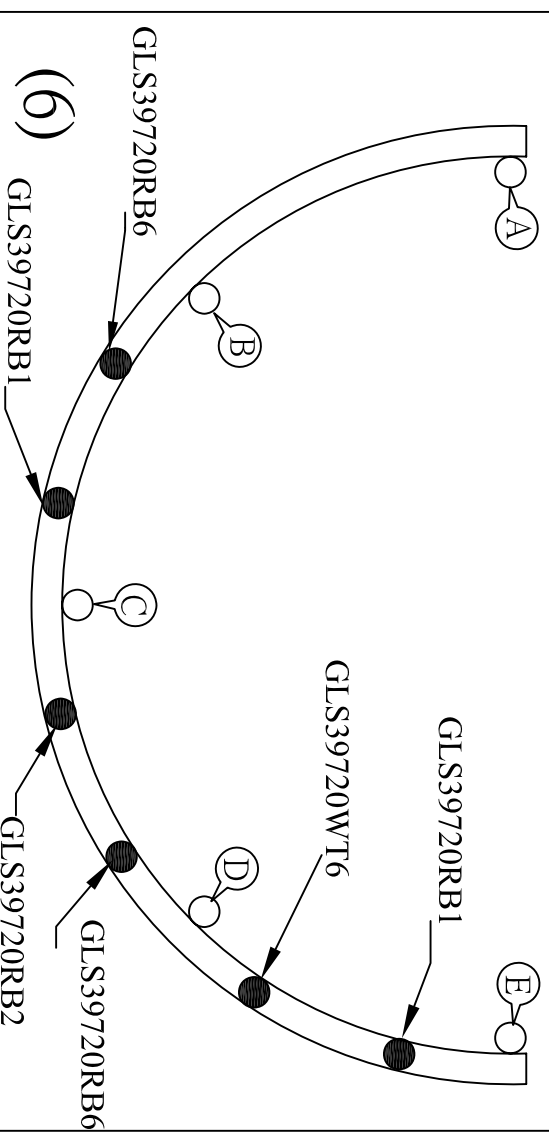
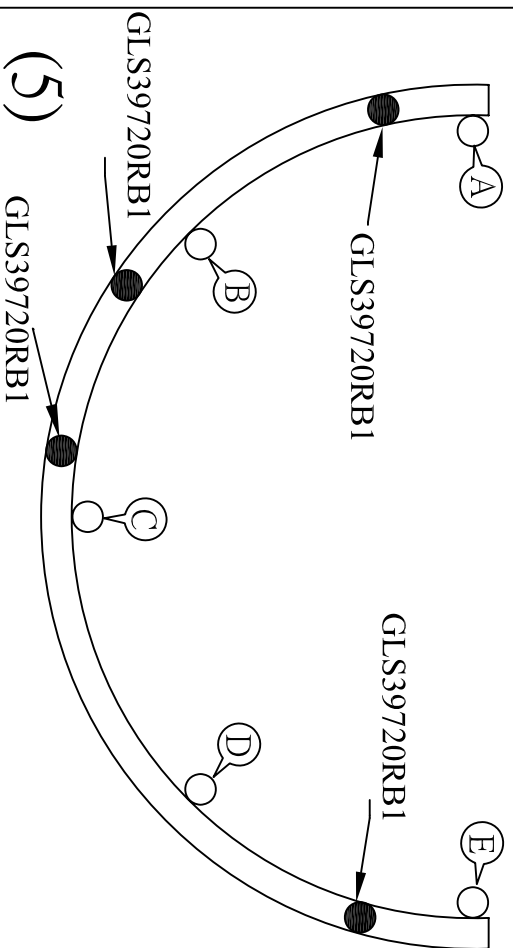
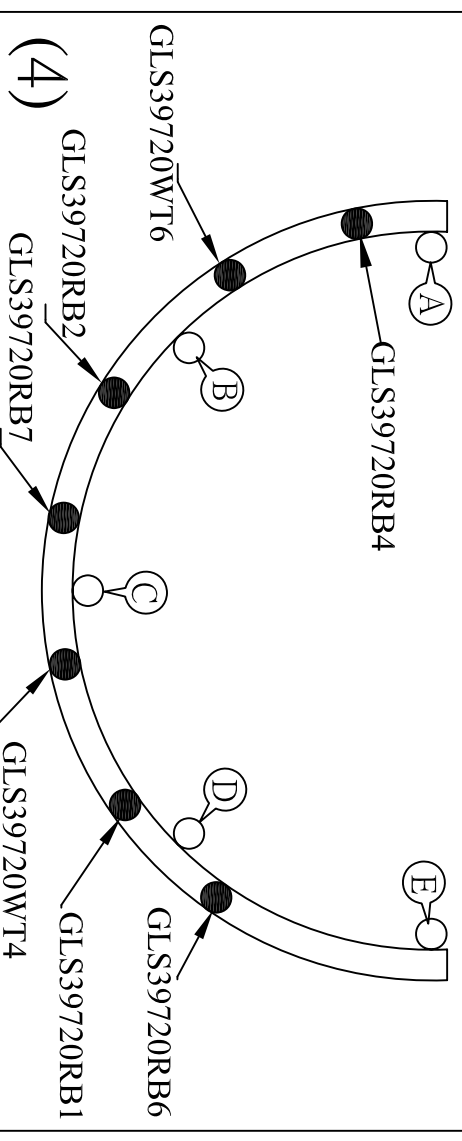
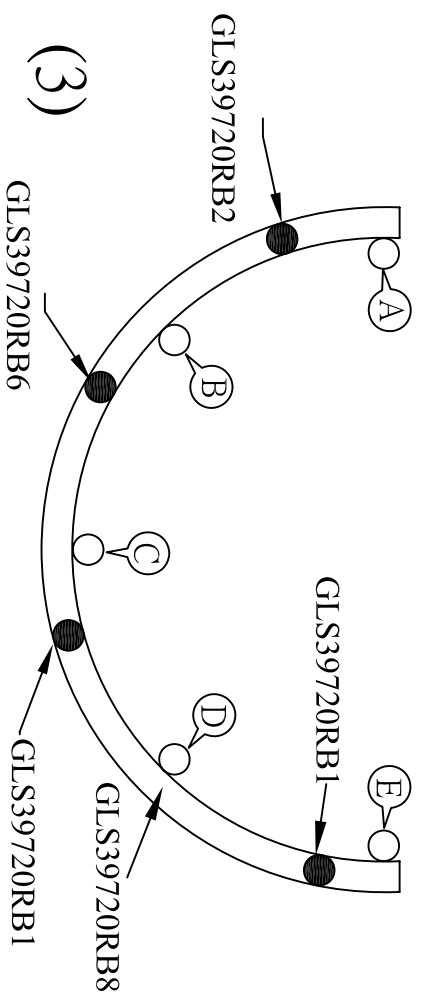
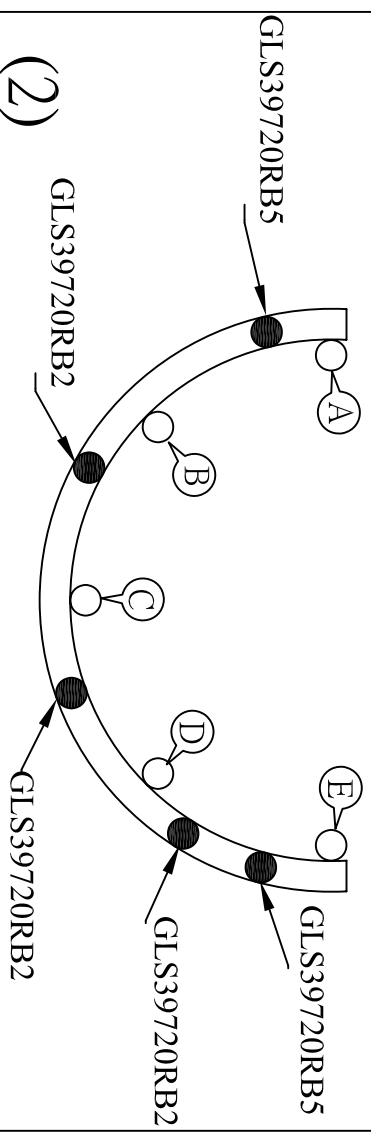
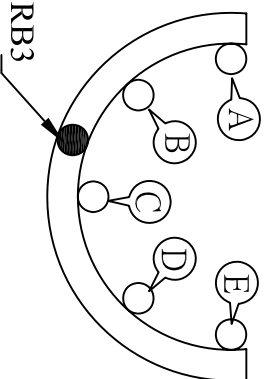

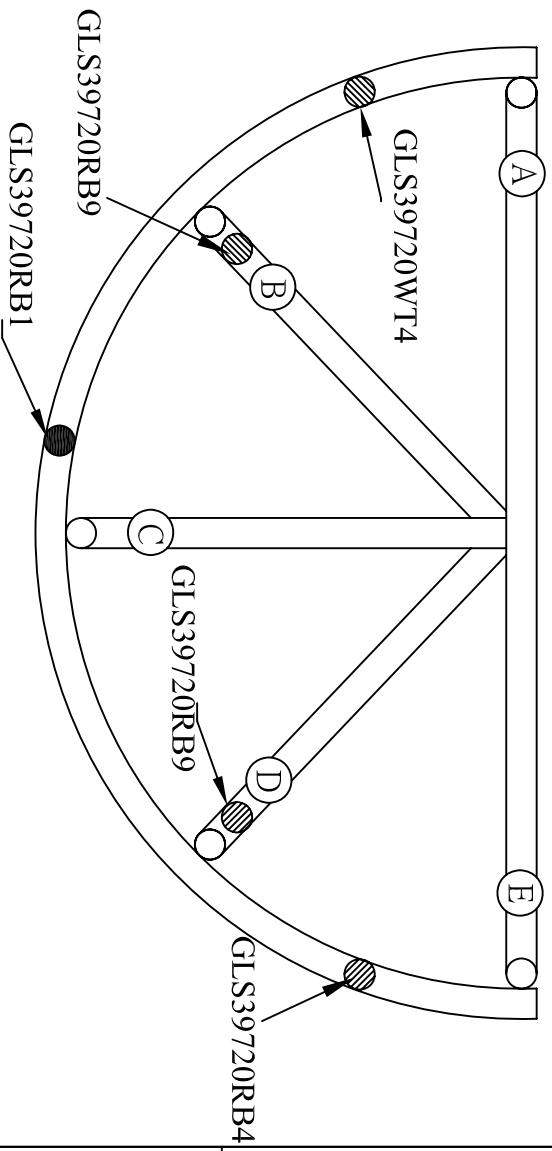

(7)

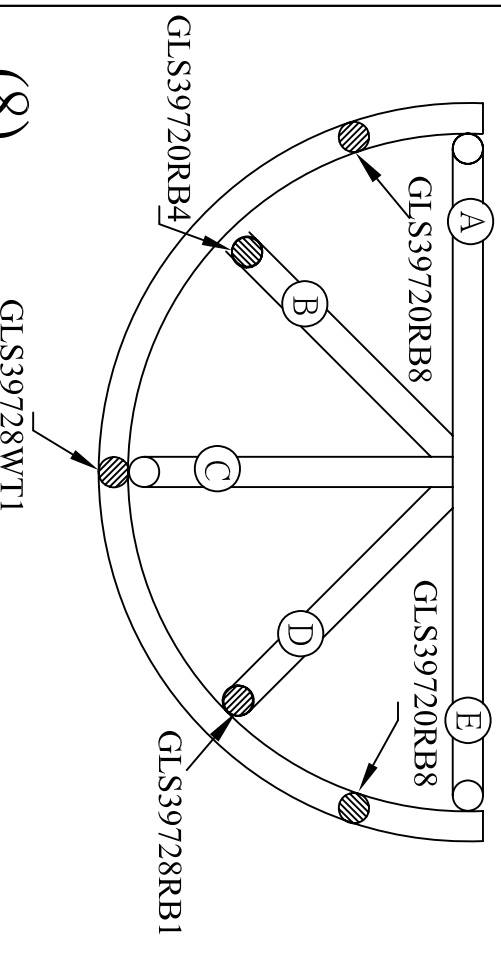

(8)

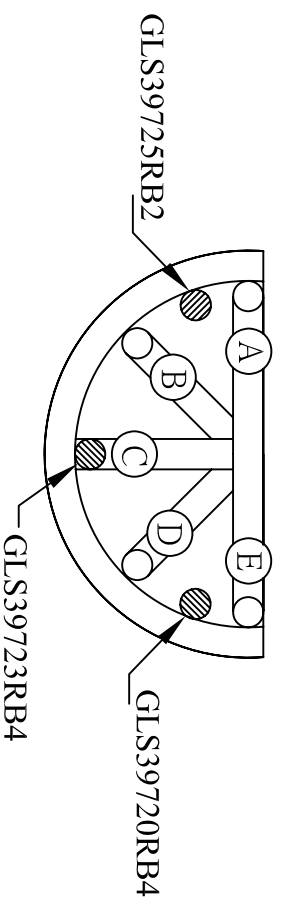

(9)

RB=Rootbeer finish WT=White finish

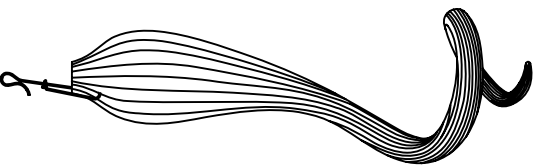

GLS39728RB1
GLS39728WT1

Glass size: 2.25"W*9.5"L

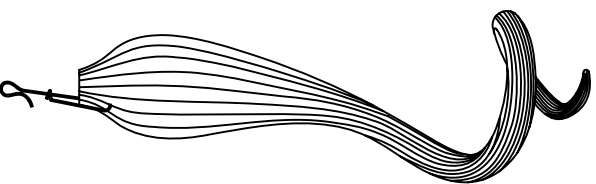

GLS39720RB4

Glass size: 2.25"W*10.5"L

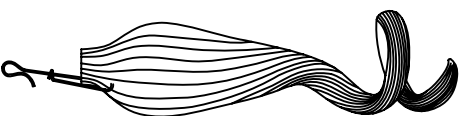

GLS39720RB6

GLS39720WT6
Glass size: 2"W*7.75"L



GLS39720RB8

Glass size: 1.5"W*11.5"H

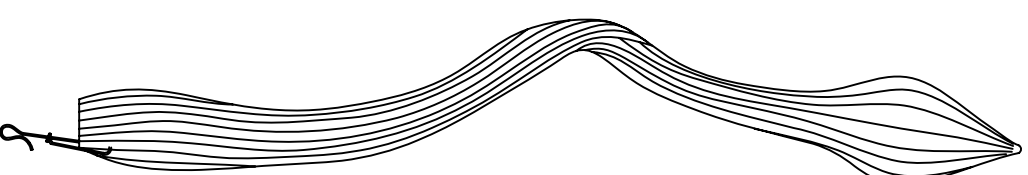

GLS39723RB3

Glass size: 1.5"W*15.75"H