

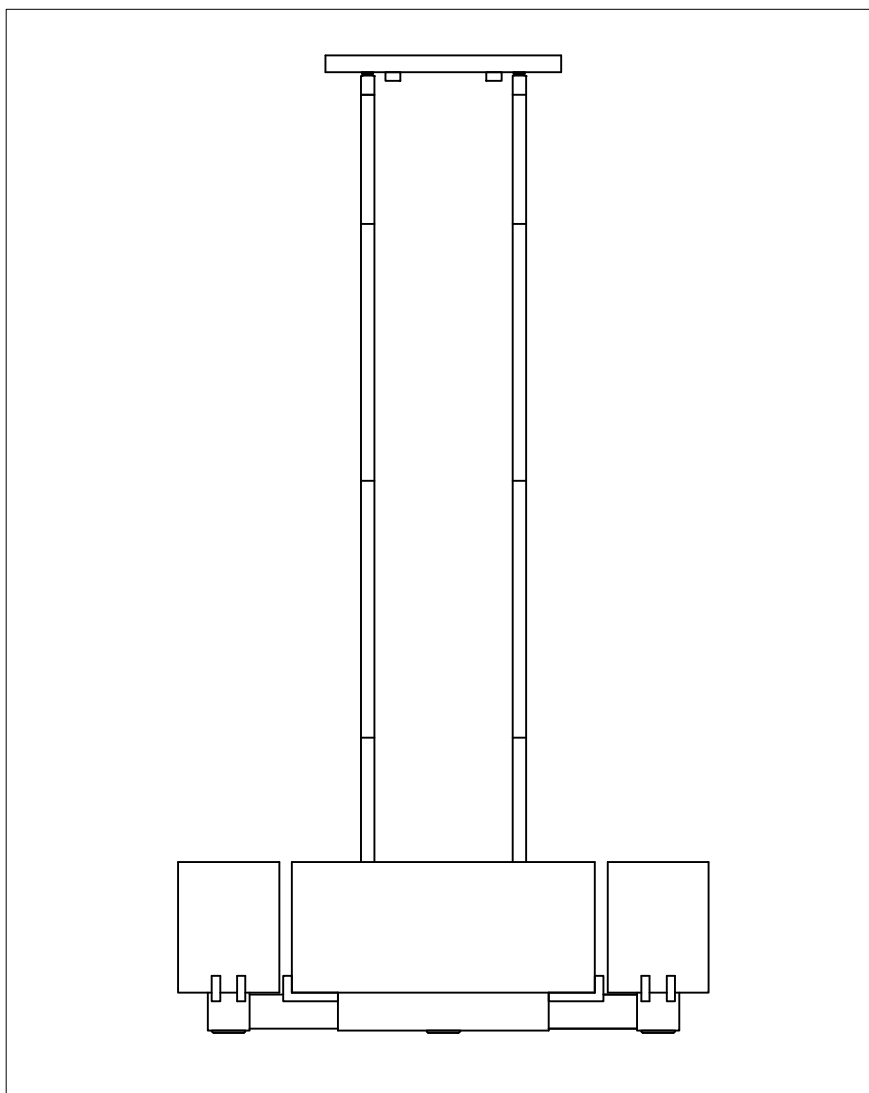

PRODUCT NAME: Esquire
ITEM NUMBER: 43667

Please consult your electrician for hanging fixture and wiring.



Bulb(included): 8 x GU24 LED 9W+4 x LED 2.5W

IMPORTANT: Turn off the power at the main fuse or circuit breaker box before starting installatio

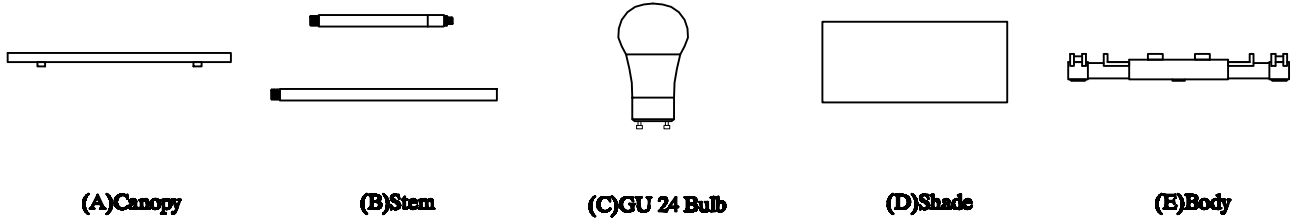

Locate all hardware & components before discarding packaging

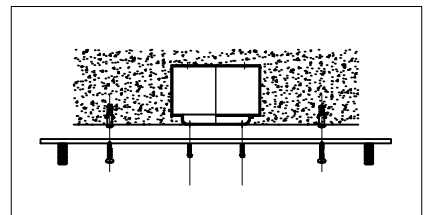
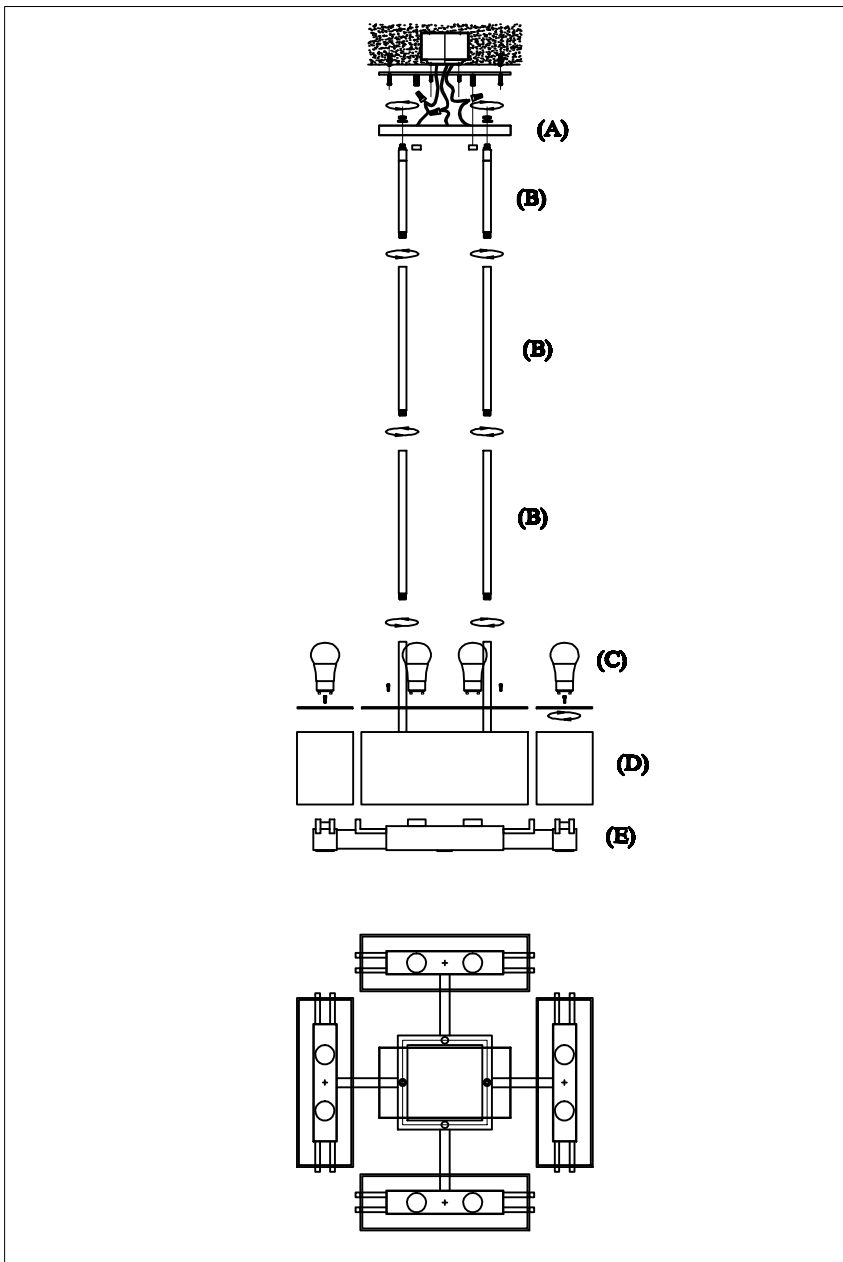

1.)

Step.1: Remove mounting bracket from fixture and install to electrical box

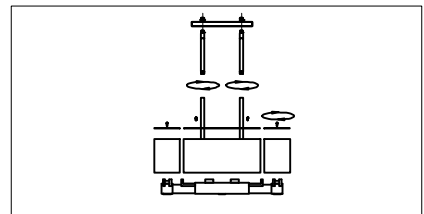

2.)

Step.2: Run wire through stems (B) and combine setm lengths to meet desired mounting height

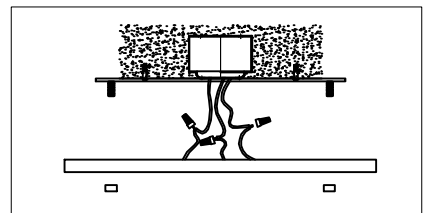

3.)

Step.3: Wire fixture to wires in outlet box. Copper/Green wire is for Ground. Install fixture to bracket and tighten screws at the ends of the canopy (A) to secure

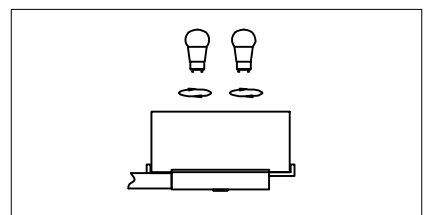

4.)

Step.4: Secure the lamp shade to the lamp body using the screw ring provided. Install the GU24 bulb.

Cleaning & Care:
Clean with soft cloth and a mild detergent.
Do not use abrasive cleaner.