

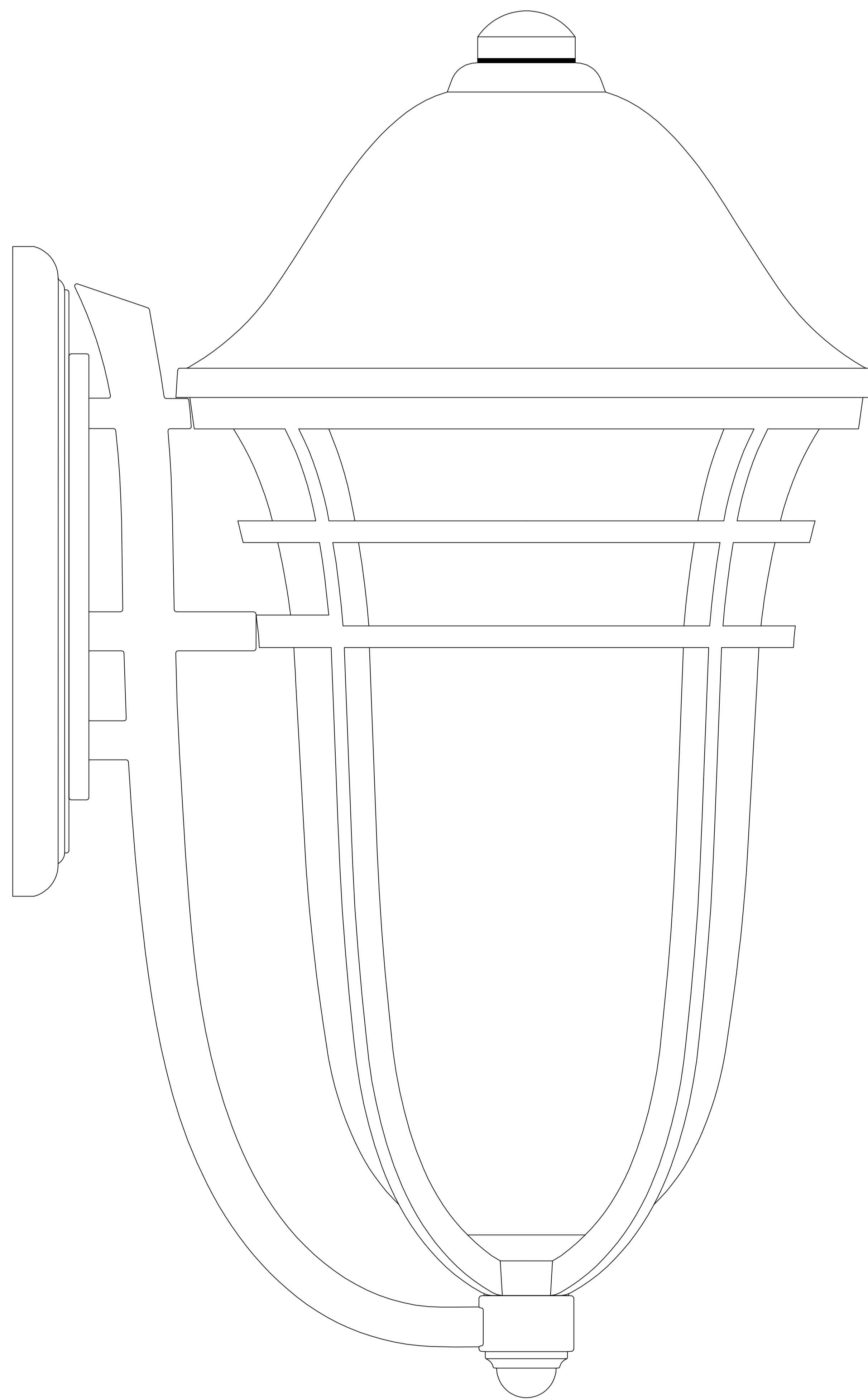

PRODUCT NAME: Westport
ITEM NUMBER: 84105

Please consult your electrician for hanging fixture and wiring.



To prevent water intrusion, caulk around back-plate where fixture meets the wall using outdoor silicone sealant. Leave a small gap at the bottom to allow moisture to exit.

Bulb (included) : GU24 1 × 26W



PRODUCT NAME: Westport
 ITEM NUMBER: 84105

IMPORTANT: Turn off the power at the main fuse or circuit breaker box before starting installation.

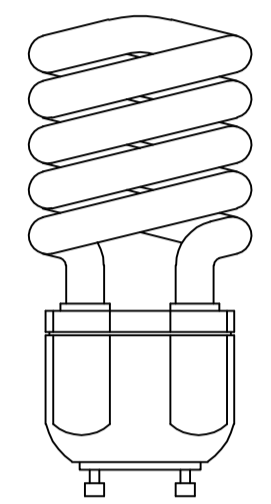
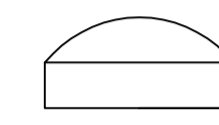
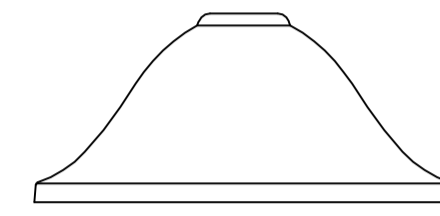
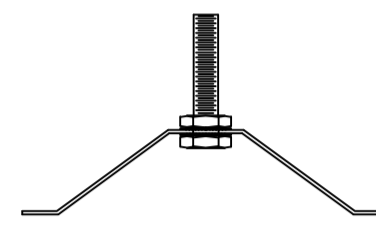
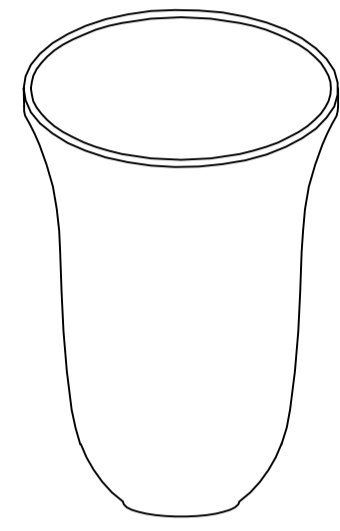
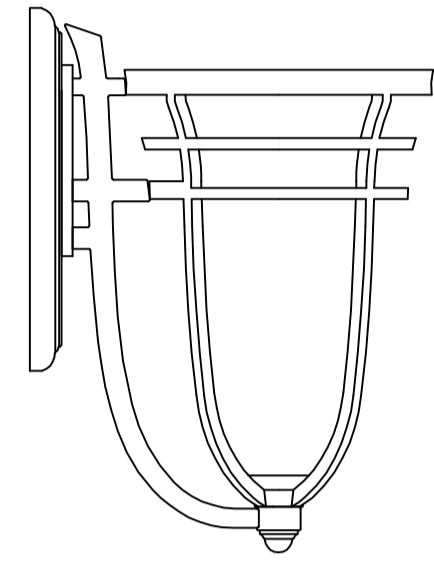
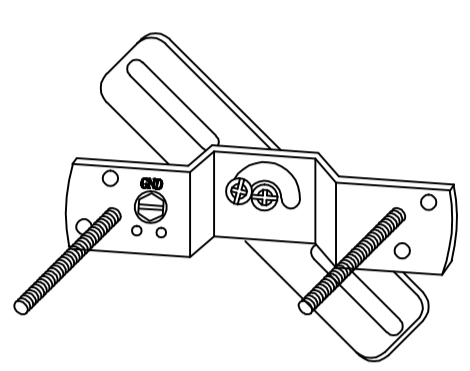

Bracket (A) Fixture (B) Glass (C) Trestle (D) Hood (E) Finial (F) GU24 Bulb (G)

Locate all hardware & components before discarding packaging

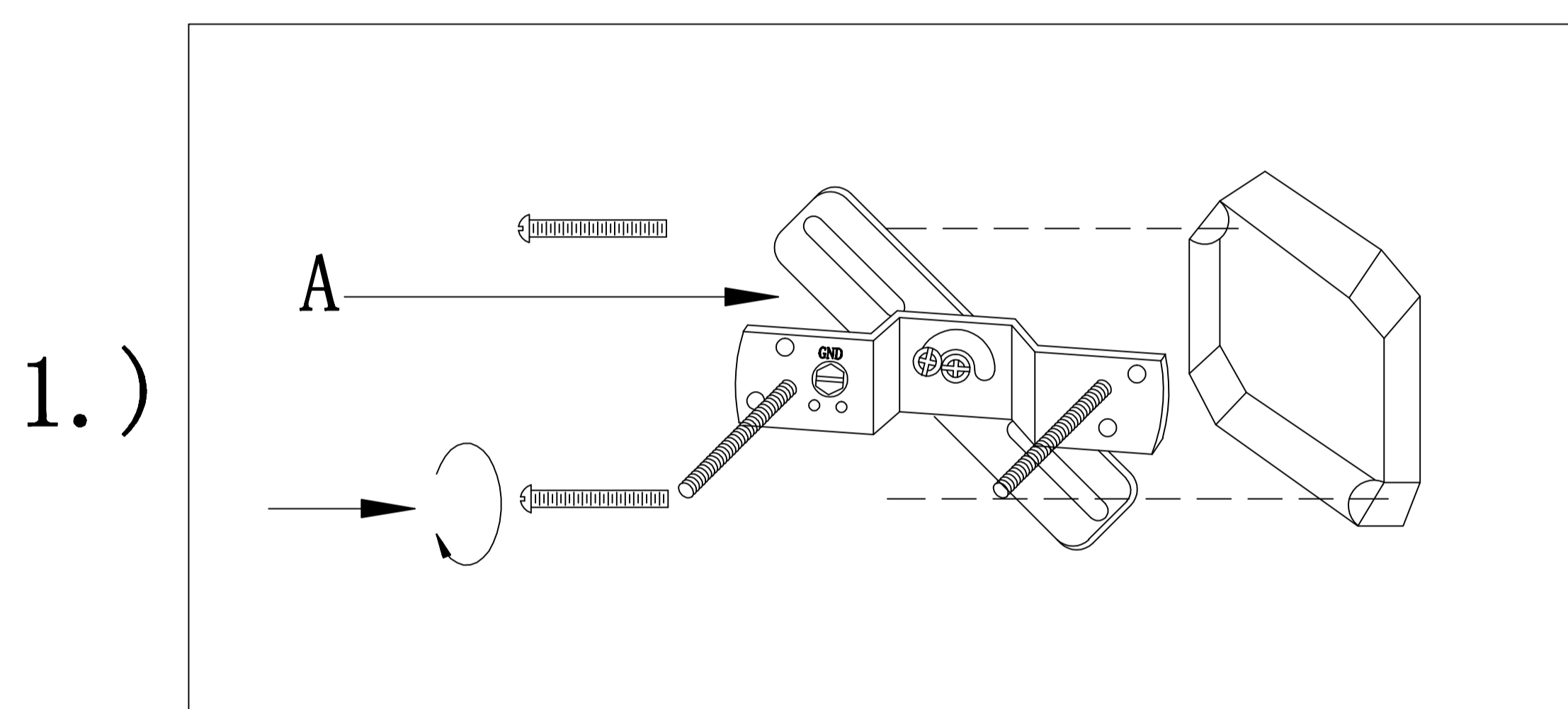

1.) Step.1: Remove mounting bracket from fixture(B) and install to electrical box. then wire fixture to wires in outlet box. Copper wire is for Ground.

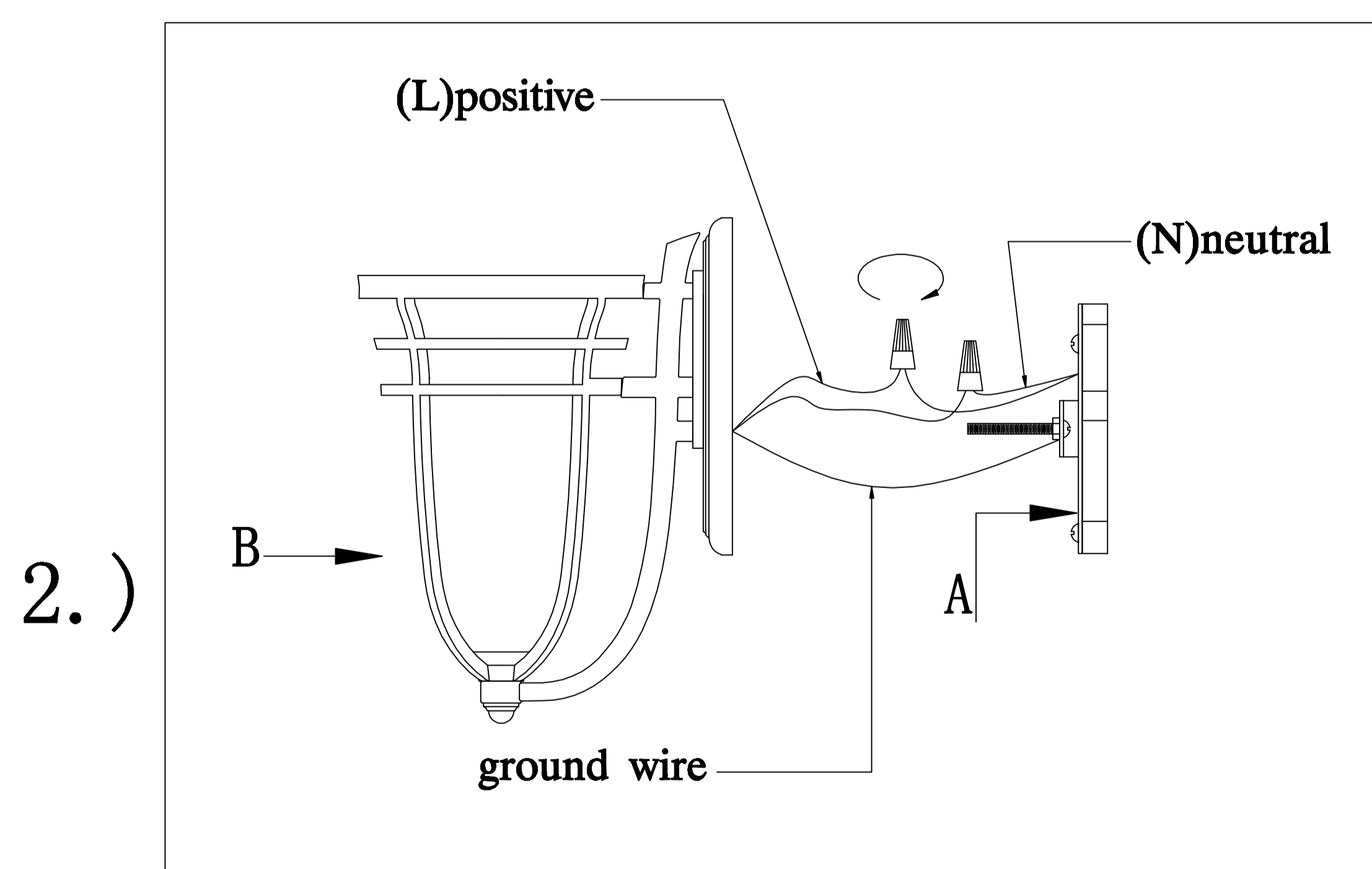

2.) Step.2: Attach back plate to mounting bracket and tighten ball nuts so fixture meets wall. Caulk fixture where back plate meets the wall with silicone sealant.

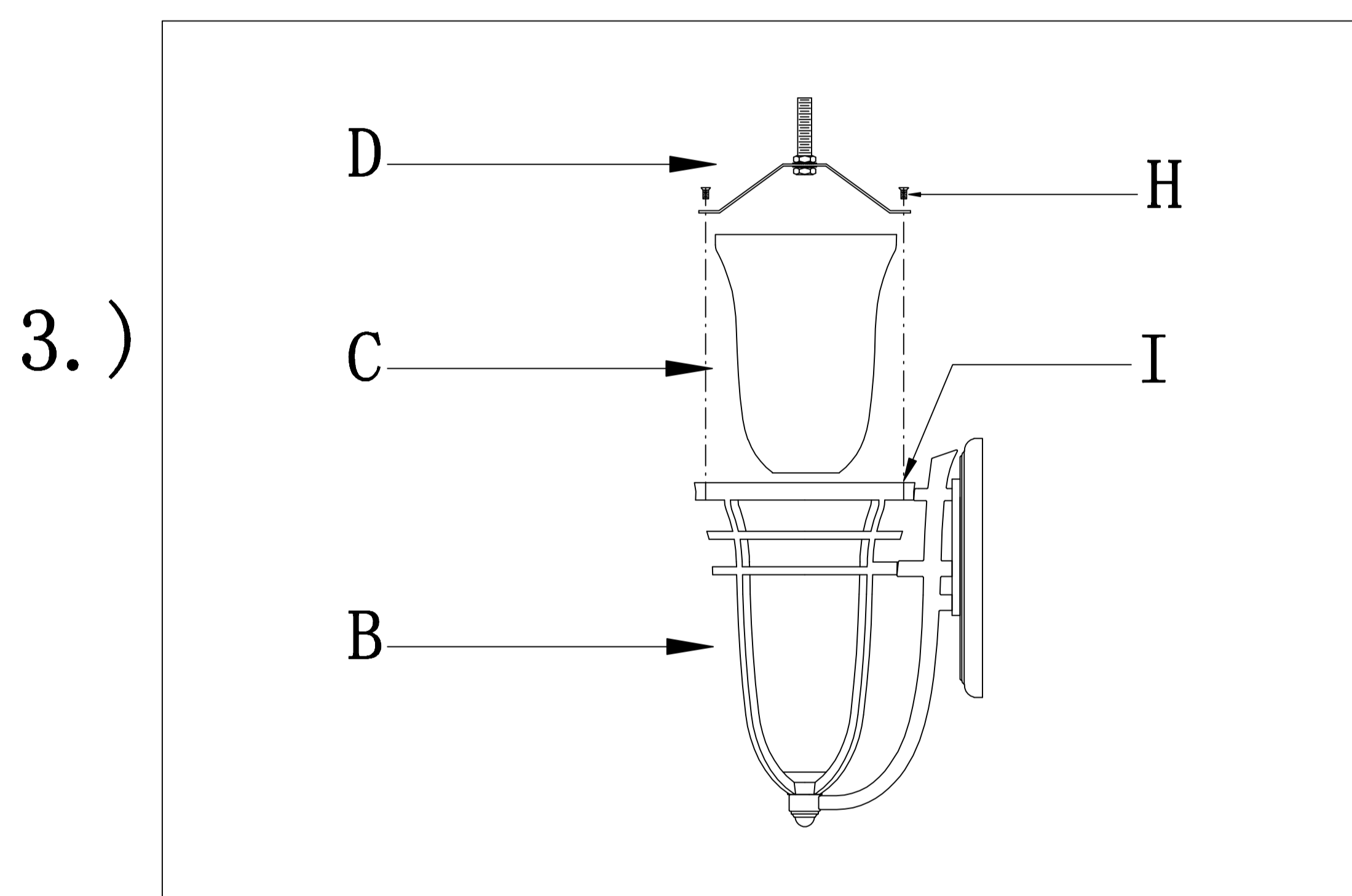

3.) Step.3: Attach glass(C) and secure using trestle(D) to the fixture using screws(H) at point(I).

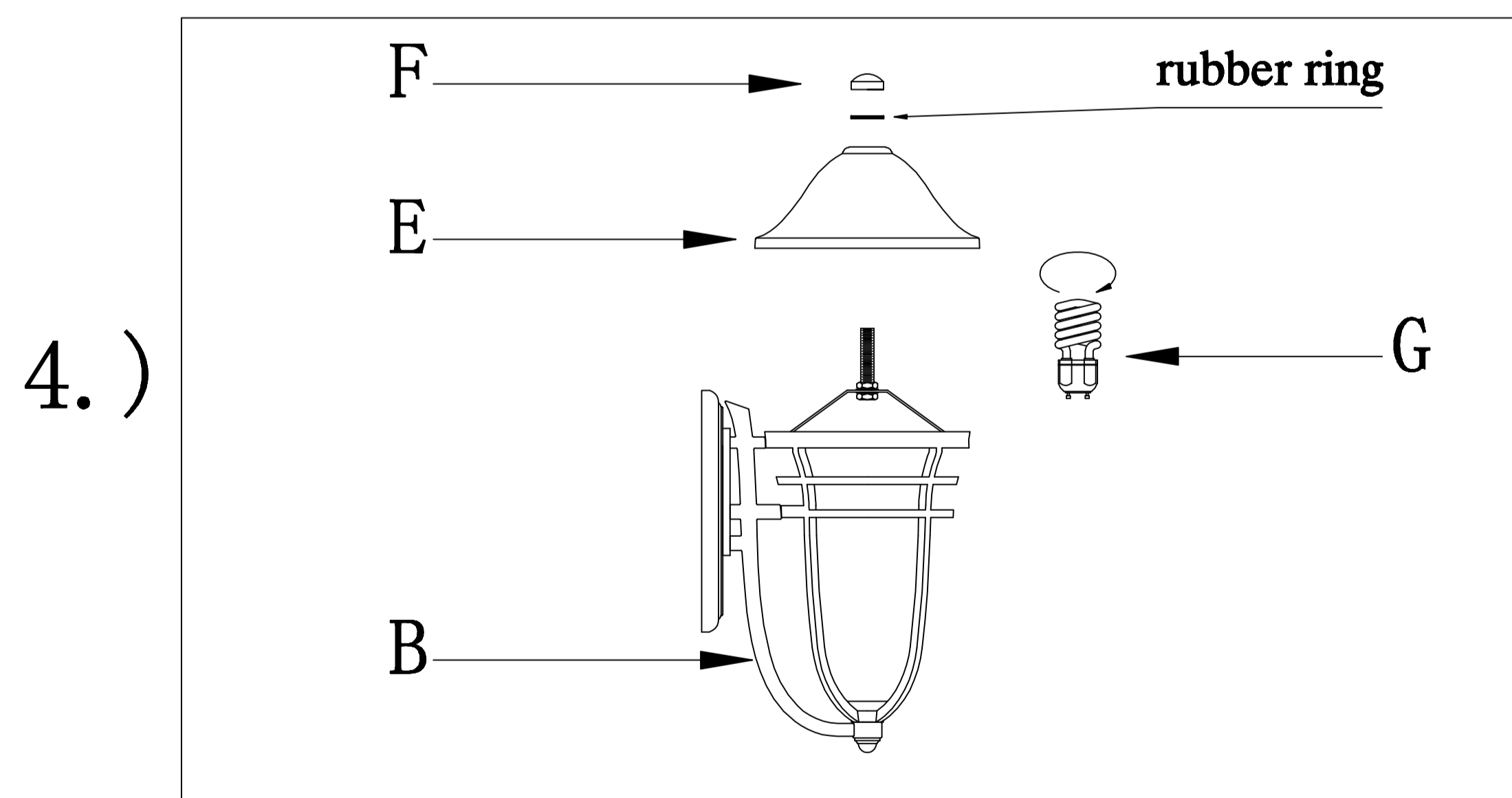

4.) Step.4: Install GU24 bulb(G), attach hood(E) and finial(F).

Cleaning & Care:
 Clean with soft cloth and a mild detergent.
 DO not use abrasive cleaner.