

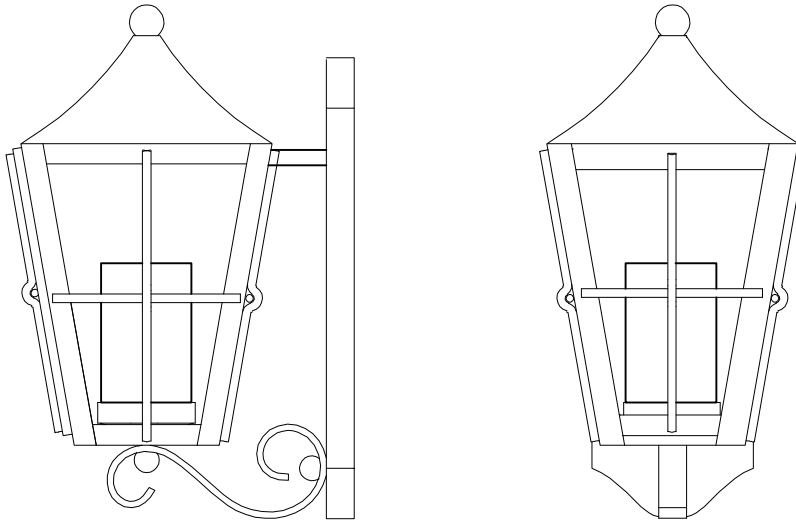

**PRODUCT NAME:CELLING MOUNTS**  
**ITEM NUMBER:85335CDFTBK**

**Please consult your electrician for hanging fixture and wiring.**



**Bulb(not included): 1 x 18W GU24**

**IMPORTANT:** Turn off the power at the main fuse or circuit breaker box before starting installation.



Bracket (A)



Glasses (B)  
GLS85330CD 4PCS



Body (C)

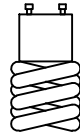

GU24  
Bulb (D)



Candle  
Cover (E)

Locate all hardware & components before discarding packaging

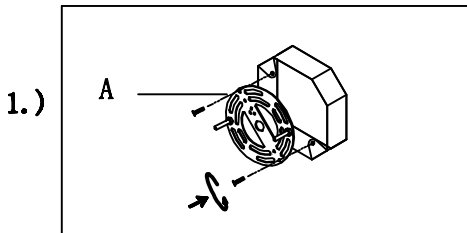

**Step.1:** Remove mounting bracket (A) from fixture and install to electrical box

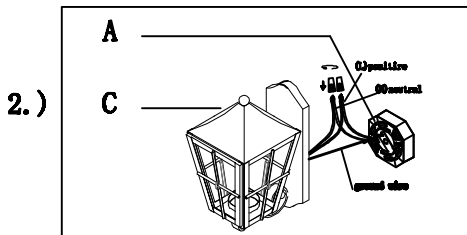

**Step.2:** Wire fixture to wires in outlet box. C copper wire is for Ground.

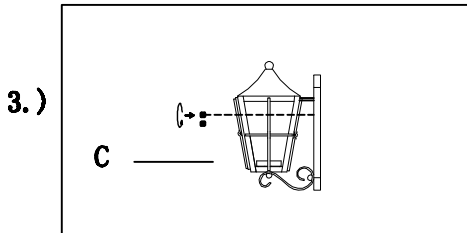

**Step.3:** Carefully remove body from fixture. Install body (C) to bracket and tighten screws on the sides of the canopy to secure. Caulk fixture with silicone sealant to prevent water from permeating."

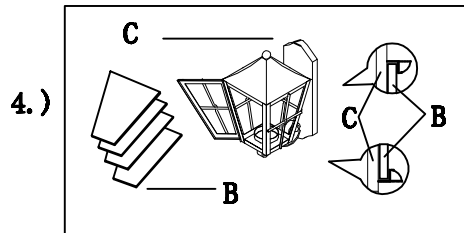

**Step.4:** Insert glass (B) and secure using glass clips

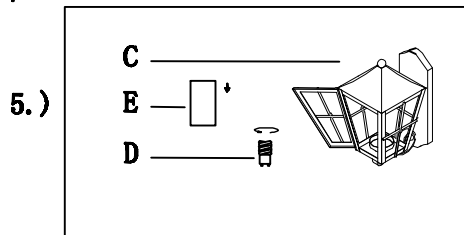

**Step.5:** Install GU24 bulb (D) and cover with Candle Cover (E)

**Cleaning & Care:**

Clean with soft cloth and a mild detergent.  
Do not use abrasive cleaner.