

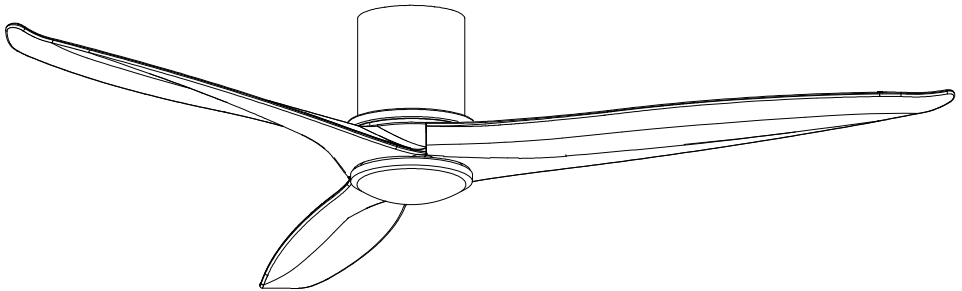

L I G H T I N G

Item/Model Num: 88830

WOODWIND 52" Solid Wood Blade Hugger Fan with
LED Light Kit 3CCT



Lamping | Ampoule: 18W LED (Included)

Weight | Poids: 52"-10.5 lbs(4.7kg)

Please consult a qualified electrician prior to install

Veillez consulter un électricien qualifié pour suspendre le luminaire et le câblage.

Installation and safety instructions Read and save these instructions

Instructions d'installation et de sécurité lisez et sauvegardez ces instructions

Made in China | Fabrique en Chine | Hecho en China

SAFETY PRECAUTION

- **WARNING** -To make sure power is off before attempting installation.
- **WARNING** -Support Directly From Building Structure. When mounted directly to the building structure, appliance installation shall not expose combustible material and do not install the appliance to a ceiling with combustible finish. The installation of the appliance cannot leave the wood of the rafters or any thermal insulation exposed to the interior of the room.
- **WARNING** -To reduce the risk of fire, electric shock, or injury to persons, unplug or disconnect the appliance from the power supply before the fan installation, cleaning, or servicing.
- **WARNING** -To Reduce The Risk Of Fire Or Electric Shock, Do Not Use This Fan With Any Solid-State Speed Control Device.
- **WARNING** -To Reduce The Risk Of Personal Injury, Do Not Bend The Blade Brackets When Installing The Brackets, Balancing The Blades, Or Cleaning The fan. Do Not Insert Foreign Objects In Between Rotating Fan Blades.
- **WARNING** -Remove and immediately recycle or dispose of batteries from equipment not used for an extended period of time according to local regulations. Do NOT dispose of batteries in household trash or incinerate. Even used batteries may cause severe injury or death. Call a local poison control center for treatment information, Non-rechargeable batteries are not to be recharged. Do not force discharge, recharge, disassemble, heat above 125°C or incinerate. Doing so may result in injury due to venting, leakage or explosion resulting in chemical burns. Ensure the batteries(CR2032 3V) are installed correctly according to polarity(+ and-). Do not mix old and new batteries, different brands or types of batteries, such as alkaline, carbon-zinc, or rechargeable batteries. Always completely secure the battery compartment. If the battery compartment does not close securely, stop using the product, remove the batteries, and keep them away from children.
- Remove and immediately recycle or dispose of batteries from equipment not used for an extended period of time according to local regulations.
- The installation is to be in accordance with the National Electrical Code , ANSI/NFPA 70-1999 and local codes. Consult a qualified electrician if in doubt.
- **WARNING** -To Reduce The Risk Of Electric Shock, This Fan Must Be Installed With A General-Use, Isolating Wall control/Switch.
- All set screws must be checked, and re-tightened where necessary before installation.
- After making the wire connections, the wires should be spread apart with the grounded conductor and the equipment-grounding conductor on one side of the outlet box and the ungrounded conductor on the other side of the outlet box.
- The splices after being made should be turned upward and pushed carefully up into the outlet box.
- Conductor of a fan identified as grounded conductor to be connected to a grounded conductor of power supply, conductor of fan identified as ungrounded conductor to be connected to an ungrounded conductor of power supply, conductor of fan identified for equipment grounding to be connected to an equipment-grounding conductor.
- **CAUTION** -To Reduce The Risk Of Electric Shock, Disconnect The Electrical Supply Circuit To The Fan Before Installing Light Kit.
- **WARNING** -To reduce the risk of fire, electric shock, or personal injury, mount directly to a structural framing member or to an outlet box marked (acceptable for fan support of 15.9 kg(35lbs) or less). For outlet box mounting, use mounting screws provided with the outlet box. Must check that the outlet box is securely installed in place before install.

I、Precautions

Before using this ceiling fan, please read this manual carefully and operate strictly in accordance with the procedures.

- 1 The input voltage of this product: 120V/60Hz
- 2 If you have insufficient knowledge of electrical appliances, be sure to hire an experienced expert to install them.
- 3 Before installing and disassembling the ceiling fan light, please turn off the power first. The installation must be installed in the order of ground wire, live wire, and neutral wire. Before disassembly, it must be disassembled in the order of neutral wire, live wire and ground wire to avoid electric shock.
- 4 The ceiling fan must be installed on a solid ceiling, and the location of the ceiling fan must be able to withstand a gravity greater than 60 KG.
- 5 When installing the ceiling fan, all screws must be securely locked.
- 6 When the ceiling fan is rotating, no objects should touch the blades to avoid danger.
- 7 The angle and elevation of the leaf frame are determined after many repeated measurements, so it cannot be changed at will. When installing the leaf frame and blades, special care should be taken not to force collisions. If the angle and elevation angle of the leaf frame are deformed that will cause the ceiling fan to shake.

II、Prepare tools before installation:



Electrical
Adhesive tape



14 open
spanner



Slotted
Screwdriver



Phillips
screwdriver



Telescoping
ladder



Pliers

III、Installation steps and instructions

1 Ceiling Fan Kit

Ensure the following accessories are included in the carton before installation.



1*Motor

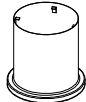

1*housing



1*mounting plate

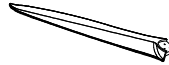

3*Blades



1*Lamp Plate+LED



1*Lampshade



1*Decorative cover

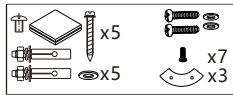

1*Screw package

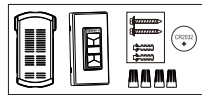

1*Remote control
1*Receiver



1*Instruction

IV、Mounting plate Installation

1. Secure the mounting plate.

First remove the mounting plate from the housing, (Figure 1), there are two different kind of screws to fix the plate, one work for concrete ceiling and the other work for wood ceiling(Figure 2), choose the right screws to fix the ceiling fan(Figure 3&4)

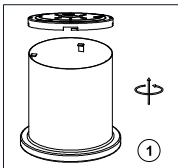

①

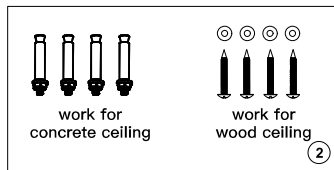

work for
concrete ceiling

work for
wood ceiling

②

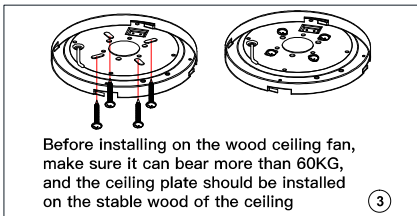

Before installing on the wood ceiling fan, make sure it can bear more than 60KG, and the ceiling plate should be installed on the stable wood of the ceiling

③

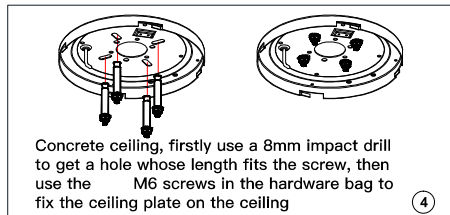

Concrete ceiling, firstly use a 8mm impact drill to get a hole whose length fits the screw, then use the M6 screws in the hardware bag to fix the ceiling plate on the ceiling

④

TIPS: Using different screws to secure the ceiling plate according to the different material of the ceiling, please do not install the ceiling plate on the ceiling which is unable to bear 60KG to prevent any potential danger. After the ceiling plate is located, make sure it can withstand more than 60KG, try to pull by hands to test if the ceiling is strong enough for safety.

2. Install the ceiling plate to the outlet box
 - a. Take off the screws on the outlet box.
 - b. Install the ceiling plate to the outlet box by screws

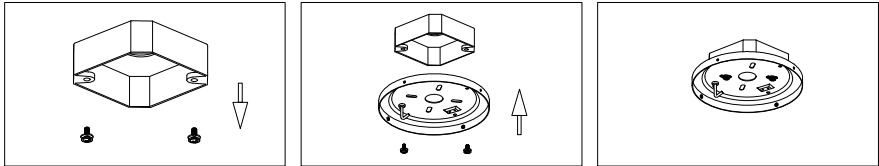

WARNING: To reduce the risk of fire, electric shock, or personal injury mount to an outlet box marked " Acceptable for Fan Support " . Use the mounting screws provided with the outlet box .Most outlet boxes commonly used for supporting lighting fixtures are not acceptable for fan support and may need to be replaced. Consult a qualified electrician if in doubt

V .Fan Motor installation and Wiring

- a. As shown in the figure 5, remove the four fixing screws on the ceiling plate, then take out the motor from the package.
- b. put the steel safety cable latch of the motor hangs into the ceiling plate hook, the four set screws though the hole of the hanger bracket and secure to the ceiling plate. (Figure 6)
- c. Take out the receiver from package, and connect the receiver wire to the motor wire together, (Figure 7-8)
- d. After the receiver wiring is completed, insert the receiver between the hanger bracket and ceiling plate.(Figure 9-10)

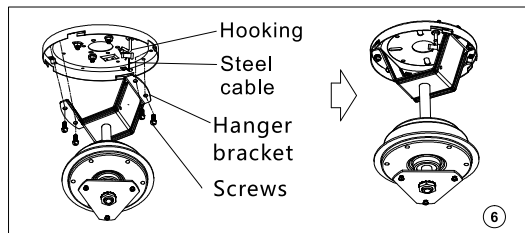
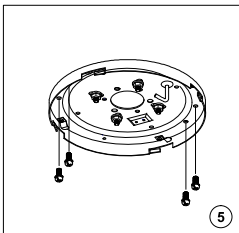

Controller wiring Diagram

7

Figure(with light)

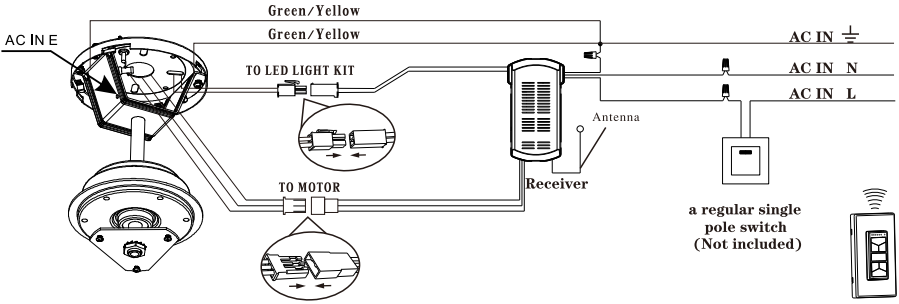

Controller wiring Diagram

8

Figure(without light)

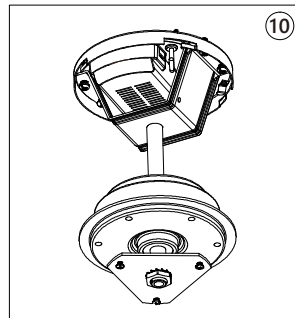
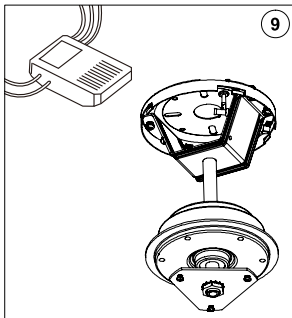
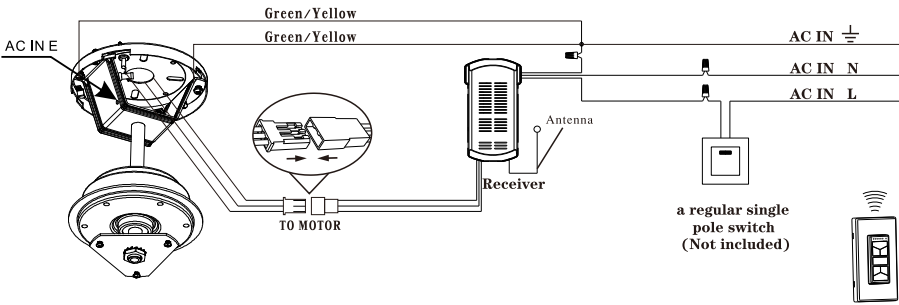

ATTENTION:

Make sure the power is off when you are connect in these wires for safety, and make sure every wires is connected right place.

4. Wiring method of receiver (Figure 7-8)

1. Connect the ground wire from ceiling to three green/yellow wires from the mounting bracket, and the receiver (AC IN E)
2. Connect the neutral wire from ceiling to receiver white wire (AC IN N).
3. Connect the live wire from ceiling to receiver black wire (AC IN L).
4. Plug in the motor wires in the correct way as indicated in the diagram.
5. Plug in the light wires in the correct way as indicated in the diagram. (Only for models with lights)

Note: The slotted side of the plug face the slotted side of the socket.

VI. Fan Housing Installation

- a. Align the lug of the housing with the notch of the ceiling plate, and rotate it clockwise to clamp the housing. (Figure 11)

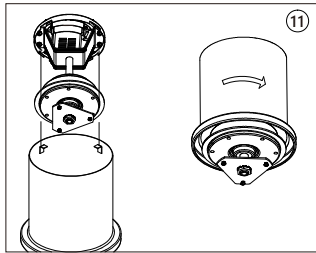

VII. Fan Blades Installation

1. Prepare the blade screws and Fan-shaped gasket in the hardware bag. (Figure 12)
2. Install the fan blades, ensure the holes are aligned with the motor plate and secure with screws. (Figure 13)

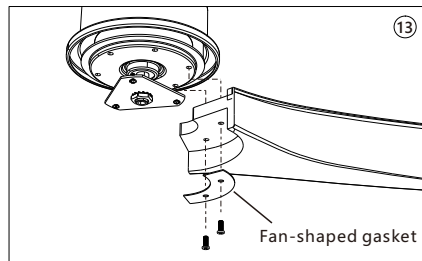
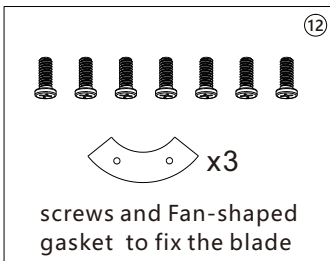

VIII. Light-Kit Installation

Installation with Light-Kit

1. Remove 3 fixing screws from the lamp holder (Figure 14).
2. Plug in the light wire plug to the LED board properly. Secure the LED board to the lamp holder with 3 fixing screws (Figure 15-16).
3. Install the lamp shade and rotate clockwise (Figure 17).

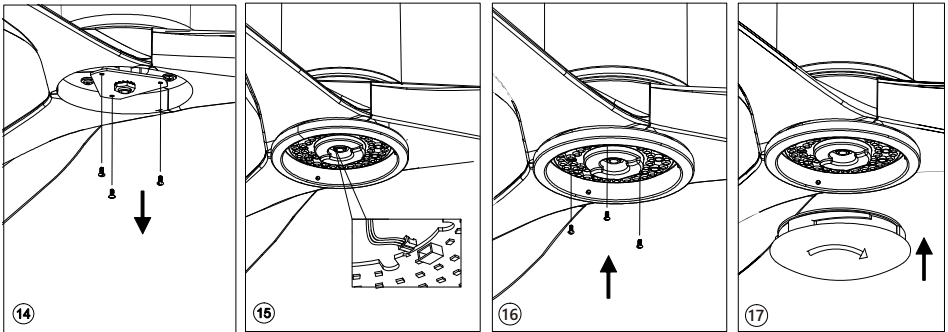

Installation without Light-Kit:

1. Remove 3 fixing screws from the lamp holder (Figure 18).
2. Secure the lamp plate to the lamp holder with 3 fixing screws (Figure 19).
3. Install the decorative cover and rotate clockwise (Figure 20).

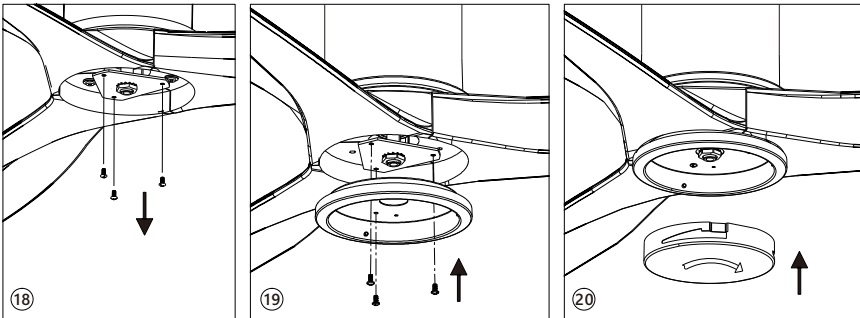

IX. Balance adjustment method of ceiling fan.

If there is any wobble after ceiling fan installation, please confirm whether the screws that fix the hanger ball, mounting bracket, hanger, blade holder, and blade are locked. If one of the above parts is not locked, please re-lock it. If it is locked, please adjust it as follows.

1. Change the position of the fan blades:

a. There is no improvement after the swap blades position. Please remove the fan blades 2 and 3 and re-lock each other to observe the effect.

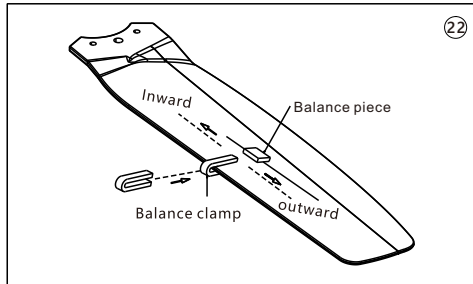
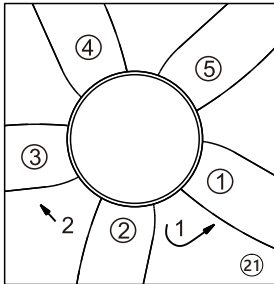

2. Adjust with balance kit.

- a. Take out the balance bag from the package box, use a balance clamp to select one of the fan blades and clamp the balance clamp on the edge of the tail end of the fan blade (Figure 22)
- b. Turn on the fan switch to see whether the wobble of the ceiling fan has been reduced. If it does not improve, try another fan blade. Experiment with all the fan blades in turn to find the blade with the weakest clamping balance.
- c. Clamp the balance clamp on the fan blade with the weakest wobble, move it in or out on the edge of the fan blade, turn on the ceiling fan to find the best position of the balance clamp to control the wobble balance (Figure 22)
- d. Take the balance sticker, tear off the double-sided tape of the balance sticker, and stick the balance sticker on the center of the blade at the position of the balance clip (Figure 22)

X .Precautions

Warning

In order to prevent fire and electric shock, it is forbidden to install and use the electric switch which is not equipped with this ceiling fan.

Maintenance and repair of ceiling fans

1. It is recommended to check the connecting parts of the fan at least once a year, such as the hanger, the hanging pipe fastening screw and the fan blade, to ensure that their connection is still safe and reliable.
2. Clean the ceiling fan regularly to keep the surface clean and clean. When removing surface dust, please use a soft brush or cloth. When removing oil or laminate, wipe it off with a slightly wet cloth. Do not rinse with water directly.
3. Motor bearing is already provided with grease, do not add lubricating oil to the motor of ceiling fan. To avoid scratching the surface.

XI .Ceiling Fan Troubleshooting Solutions & Common Problems

Can't start	1. Check whether the fuse of the external power line of the ceiling fan is blown, whether the automatic protection switch is tripped and the circuit is broken.
	2. Check whether the voltage is seriously lower than the rated voltage of the ceiling fan.
	3. Check whether the internal wiring of the ceiling fan is loose or has poor contact.
Noise	1. Ensure the ceiling fan is not severely impacted before installation
	2. Make sure that the hanging pipe connecting bolt is installed correctly and the hanging pipe solenoid is locked.
	3. The new ceiling fan allows a 24-hour "trial period", after the trial period, most of the ceiling fan noise will disappear.
	4. It is not recommended to install on wooden ceilings, steel structures or prefabricated panels, as this will amplify the sound.
The lamp is defective	1. Check whether the connection wire of the lamp is loose.
	2. Check whether the light switch is damaged, the wire end is loose or the contact is poor.
	3. Check whether the light source is burned out
Fan wobble	1. Check whether the mounting bracket is locked
	2. Check if the screw of the lock blade is locked
	3. Check whether the screw of the blade retracted to the motor is locked
	4. Can it be installed on the inclined ceiling? Yes, pay attention to the inclination angle not exceeding 15 degrees (pay attention to whether the hanger ball will press the fan receiver)



WARNING / AVERTISSEMENT



- **INGESTION HAZARD:** This product contains a button cell or coin battery. (CR2032 3V)
- **DEATH** or serious injury can occur if ingested.
- A swallowed button cell or coin battery can cause **Internal Chemical Burns** in as little as 2 hours
- **KEEP** new and used batteries **OUT OF REACH OF CHILDREN**
- **Seek immediate medical attention** if a battery is suspected to be swallowed or inserted inside any part of the body.
- **DANGER D'INGESTION:** Ce produit contient une pile bouton ou une pile monnaie.
- Si ingéré, il peut entraîner **LA MORT** ou des blessures graves.
- Avaler une pile bouton ou une pile à monnaie peut provoquer des **Brûlures Chimiques Internes en 2 heures.**
- **GARDEZ** les piles neuves et usagées **HORS DE PORTÉE DES ENFANTS**
- Si vous soupçonnez que la batterie a été avalée ou insérée dans une partie de votre corps, **Consultez immédiatement un médecin.**

REMOTE FUNCTION (MODEL: FRM8883_WT)

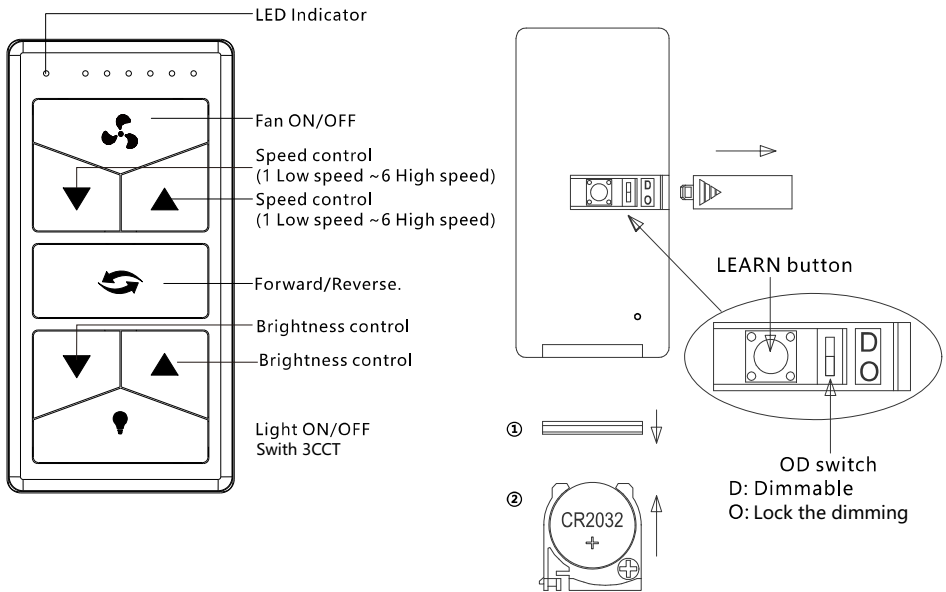

※ Remove the adhesive strip and insert the battery into it.

KINDLY REMINDERS:

1. Press the "Light ON/OFF" button continuously to switch the color temperature. Each press once, the color temperature change on once. The color temperature has memory function. If the light is turned off for more than 5-8 seconds and then turned on again, it will maintain the color temperature as it was before the light was turned off.
2. On the back of the remote control, there are "O" and "D" switches. In D mode, you can adjust the brightness by the "+" and "-" buttons. If you only want to set a fixed brightness during installation and make no further changes, you can switch to O mode. In O mode, the "+" and "-" buttons will not work.
3. If the emitter can not control the fan, learning code matching mode is used between emitter and receiver. Turn "ON" the supply power within 10 seconds and press the emitter's "📶" button for 5 seconds, it can load normally after hearing along sound "bee", which means learning successfully and it can works normally.
(PS: Learning mode is not accepted after turn "ON" the supply power for 10 seconds)
4. When the emitter cannot control the receiver, please check the battery switch touching normally or not, correction of the positive and negative, full or empty of the power.

5. When the emitter cannot control the receiver, please check is there any existence of similar remote controlled products nearby, then check whether they works, because remote controlled product with the same frequency will disturb each other.
6. Low voltage of battery will affect the sensitivity of the emitter and the signal reception accordingly (the indicated light will flash out its warning when the battery get low voltage), must replace if the battery is getting low voltage.
7. Please take out the battery from the emitter when leaving unused for long time.
8. When installing the fan ,the fan ceiling cover don't press the antenna(or other wire),it is easy to breakdown the wire and short-circuited.
9. If one remote control is required to control multiple fans, the operation process as below:
Switch on the power of all the fans to be controlled (within 30 square meters range). Within 10 seconds of turning on the power, press and hold the "  " button for 5 seconds. When a "bee" sound is heard, the code matching is successful.
Note: If remote not match all fans, please try again.

WALL MOUNTING THE REMOTE

REMEMBER to turn off the power before you begin.

NOTE - Secures to any surface or application: flat wall and single gang box.

Option 1. Flat Surface Installation (Figure23)

1. Select a desired location. Use the wall plate to mark the location of the mounting holes. Plastic wall anchors are needed for this application.
2. Seat the cradle into the wall plate. Secure the wall plate to the wall using the provided screws.
3. Snap the face plate cover onto the wall bracket.
4. The remote will be held in place with built in magnets.

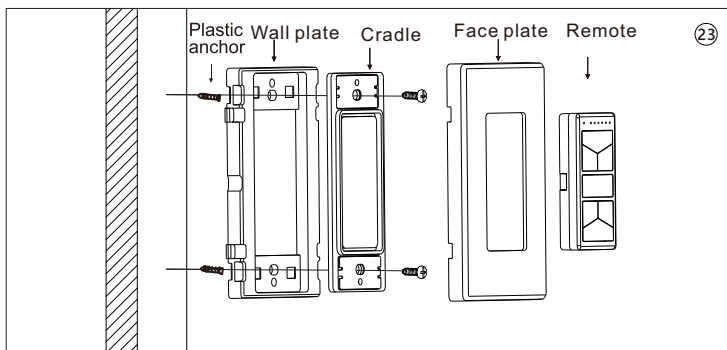

Option 2. Single Gang Box Installation (Figure24)

1. Ensure the power to the circuit is disconnected. Remove the existing wall switch from the single gang box and disconnect the wiring.
2. Position the wall plate over the single gang box, aligning its mounting holes with the box's screw holes.
3. Seat the cradle into the wall plate and secure the wall plate to the single gang box using the provided screws.
4. Snap the face plate cover onto the wall bracket.
5. The remote will be held in place with built-in magnets.

IMPORTANT: When installing onto a single gang box, the original wiring and existing wall switch in the box will no longer be usable.

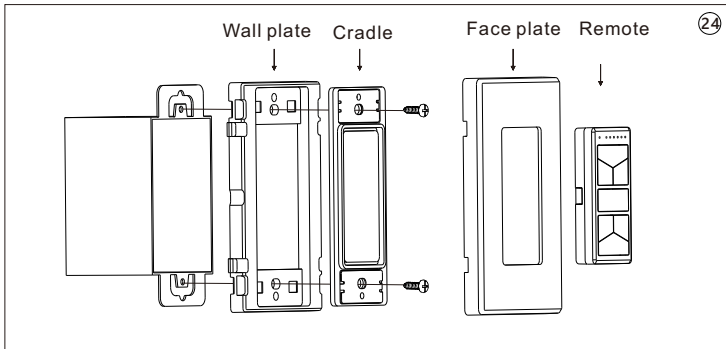

Option 3. Retrofit Installation

1. If you already have an existing wall plate, face plate, and cradle installed on the wall, simply replace the original cradle with our magnetic cradle.
2. Proceed with the installation as normal — no changes to the wall plate or face plate are required.
3. The remote will be securely held in place by the built-in magnets in our cradle.

NOTE: This installation method is compatible with standard single gang wall plates, allowing you to upgrade the remote mounting without replacing your existing wall hardware.