

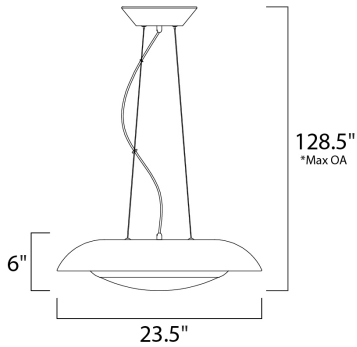

PRODUCT DESCRIPTION

Domes of metal house a circular light engine housing with a Crystalline diffuser. A dramatic lighting effect is created with in-direct light highlighting the foil lining while direct light shines through the sparkling center. Available in your choice of White with Silver Foil or Black with Gold Foil.



*max overall height

MEASUREMENTS

DIMENSION : 23.5" L x 23.5" W x 6" H
 MAX OAH : 128.5" OAH
 HANGING WEIGHT : 10.78 lb

LAMPING

INPUT VOLTAGE : 120V
 LUMENS : 2,360 Rated
 BULB : 1 x 34W LED PCB Integrated , 34W Total
 BULB INCLUDED : (Integrated)
 DIMMABLE : Triac CL
 CRI : 80+ CRI
 COLOR_TEMP : 3000K

FINISHES OPTION

 Silver Leaf / White (SLWT)

GLASS

Crystalline CY

MATERIAL

Metal

RATINGS

cETLus
 Dry Location



ADDITIONAL

ADJUSTABLE
 OPERATING TEMPERATURE:
 -20°C (-4°F), 40°C (104°F)

Always consult a qualified electrician before installing any lighting product.



WESTERN DISTRIBUTION CENTER (HEADQUARTER)
 253 NORTH VINELAND AVE | CITY OF INDUSTRY, CA 91746

EASTERN DISTRIBUTION CENTER
 101 GARDNER PARK | PEACHTREE CITY, GA 30269

P. 626.956.4200 | F. 626.956.4225 | maximlighting.com