



MAXIM[®]

L I G H T I N G

TASK LIGHTING

LED • Under Cabinet • Low Profile







Maxim Lighting has a full line of task lighting options, perfect for adding light where you need it the most in your home. Ideal for such applications as countertops, reading areas, workspaces, or anywhere a specific job or task needs to be completed. Improve productivity and reduce eye strain with the right type of task light. Under-cabinet task lighting is the ideal solution for lighting where you need it the most, install below kitchen cabinets to clearly see the task at hand. Low profile ceiling flush mount lights provide a great source of illumination more inconspicuously and unobtrusively than standard overhead lights. This task book is filled with fixtures that cover a variety of applications and designs.

COUNTERMAX®

Task Lighting

1K MX-L-120-1K LED Under Cabinet Lighting	13
2K MX-L-120-2K LED Under Cabinet Lighting	11
3K MX-L-120-3K LED Under Cabinet Lighting	9
LO MX-L120-LO LED Under Cabinet Lighting	15
SLIM LINE MX-L-120-SL LED Under Cabinet Lighting	7
SLIM STICK MX-L-24-SS LED Strip Lighting	5
AC PUCKS MX-LD-AC LED Discs	25
DC PUCKS MX-LD-D LED Discs	27
Fluorescent Direct MX-FD Direct Wire Fluorescent Under Cabinet Lighting	23
MX-X12 12V Xenon Under Cabinet Lighting	21
120V XENON MX-X120 120V Xenon Under Cabinet Lighting	17
LINKABLE XENON MX-X120c Linkable 120V Xenon Under Cabinet Lighting	19
Series Details	45

LOW PROFILE

Flush Mounts

Chip LED Flush mounts	36
Convert LED Flush mounts	43
Cove LED Recessed Downlight	30
Displays	47
Diverse LED Flush mounts	41
Illuminate II LED Flush mounts	37
LED Wrap LED Flush mounts	31
Sky LED Flush mounts	32
Trim LED Flush mounts	39
Wafer LED Wall/Flush mounts	33

COUNTERMAX™

Under cabinet and puck lighting are key ingredients in a home's lighting scheme, providing task lighting and drama to any style living space. Maxim Lighting's CounterMax fixtures work great as concealed task lights, when labor intensive activities require powerful illumination such as the utility room, office, kitchen or craft room. They also can add drama to shelves and book cases. CounterMax comes in your choice of fluorescent, xenon or LED lamping options. Designs of the CounterMax sleek and narrow profile lights make installation easy. To illuminate tighter spaces, CounterMax LED strips work well as accent or indirect lighting, creating beautiful silhouettes and ambiance. CounterMax LED discs focus pools of downlighting as exposed or recessed fixtures.



Here are some of the latest techniques to create a stylish and functional lighting scheme with the extensive line of Maxim Lighting's CounterMax fixtures.



Add Spotlight:

Put your kitchenware on display, front and center, using CounterMax puck lights inside of your cabinets. Let the light reflect on your glasses or spotlight a showcase item. These concealed downlights provide ample lighting that evenly distributes and diffuses as it reflects.



Highlight Task

Make food prep a breeze with well-lit countertops and workspace. Maxim's CounterMax collection offers sleek designs with a variety of lighting types. Our CounterMax 1K series provides a wide beam of light without breaking the bank. While the 3K series features three different light temperatures allowing you to find the right shine. The 3K has a patented gimbal designed to allow light to be directed where you want it with even light distribution and no hot spots.



Down light for Dimension:

Add space depth and texture with Maxim's line of downlights. Avoid washing out a room in overexposed light with precise lighting created by CounterMax fixtures. Use this indirect lighting to complement a more direct lighting source such as a chandelier or linear pendants.

SLIM STICK | MX-L-24-SS

LED Strip Lighting



Narrow Aluminum channels of LED are easily concealed and an economical way to tackle task lighting. Installation is simple with an adjustable bracket that allows you to direct the light where you need it and a plug-in or hard wire power supplies. Available in lengths from 6" to 48" and numerous cords and accessories, Slim Stick is the easy solution for most any installation.



89801AL
LED Strip

- Includes adjustable mounting clips

Features:

- Aluminum finish with black accessories
- Opal White Acrylic provides uniform reflectance
- 24V system must be paired with driver accessories
- Runs up to 20' with 100W driver
- Adjustable mounting clips allows for angled installation
- Dimmable with Triac dimmers and Touch dimmer
- Energy Star Certified
- Title 24 JAB Listed
- 3000K Color Temperature
- CRI 90+

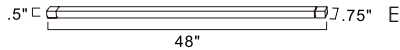
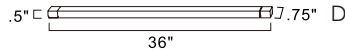
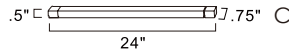
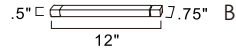
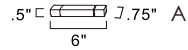

ITEM #	LAMPING	DIMENSION	CRI	LUMENS		Additional Info.
				INIT.	DEL.	
A 89800	3W 24V LED 3000K (Integrated)	6"L x .75"W x .5"H	90+	350	195	
B 89801	5W 24V LED 3000K (Integrated)	12"L x .75"W x .5"H	90+	700	390	
C 89802	10W 24V LED 3000K (Integrated)	24"L x .75"W x .5"H	90+	1050	780	
D 89803	15W 24V LED 3000K (Integrated)	36"L x .75"W x .5"H	90+	1400	1170	
E 89804	20W 24V LED 3000K (Integrated)	48"L x .75"W x .5"H	90+	1560	1400	

Finish: Aluminum(AL)



ACCESSORIES



24V 24W Plug-In Driver
89811BK
 • 120V



24V 60W Hardwire Driver
89816BK
 8.5"L • 2.5"W • 1.75"H
 • Dimmable 120-277V



24V 96W Plug-In Driver
89814BK
 • 120V



90° Connector
89830BK



Connecting Cord
 2" **89820BK**
 6" **89821BK**
 18" **89824BK**
 36" **89826BK**
 60" **89828BK**



24V 60W Plug-In Driver
89812BK
 • 120V



24V 96W Hardwire Driver
89818BK
 9.5"L • 2.5"W • 1.75"H
 • Dimmable 120-277V



In-Line Dimmer
89835AL
 • 96W, 120-277V



90° Connector
89831BK



Connecting Cord
 12" **89822BK**
 • Includes on/off switch

SLIM LINE | MX-L-120-SL

LED Under Cabinet Lighting



The newest, thinnest under cabinet model, the SL, features CRI 90+ color rendering and 3000K color temperature. 120-277V input and dimmable drivers lend them for both residential and commercial applications. Available in Bronze and White. Connect them edge-to-edge or by using connecting cables.



88901 BZ, WT
LED Under Cabinet

Features:

- 2700K and 3000K Color Temperature
- CRI 90+
- 120V-277V input drivers linkable up to 96 Watts
- Dimmable at 120V using Electronic Low Voltage
- 3/8" tall profile

Includes:

- 3/8" knockouts on driver
- Mounting screws
- Edge to edge connector
- Magnetic mounting plate

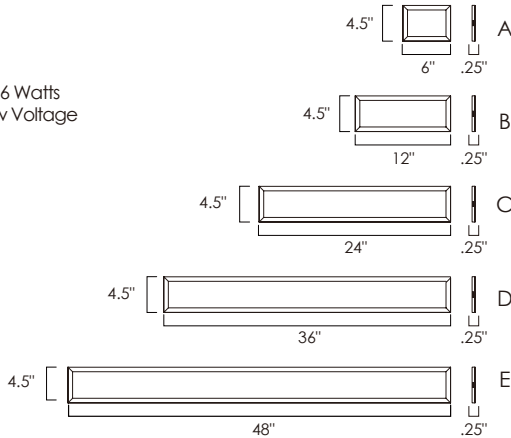

ITEM #	LAMPING	DIMENSION	BP	HCO	CRI	LUMENS		Additional Info.
						INIT.	DEL.	
A	3W 24V LED 3000K (Integrated)	6"L x 4.5"W x .25"H	1.9"W	.25"	90+	210	180	
B	6W 24V LED 2700K (Integrated)	12"L x 4.5"W x .25"H	1.9"W	.25"	90+	420	360	
C	12W 24V LED 3000K (Integrated)	24"L x 4.5"W x .25"H	1.9"W	.25"	90+	840	720	
D	18W 24V LED 2700K (Integrated)	36"L x 4.5"W x .25"H	1.9"W	.25"	90+	1260	1080	
E	24W 24V LED 2700K (Integrated)	48"L x 4.5"W x .25"H	1.9"W	.25"	90+	1680	1440	

Finish Options: Bronze(BZ) White glass(WT)



ACCESSORIES



MX-L-120-SL Connector Cord
 12" **8912 BK, WT**
 24" **8924 BK, WT**
 72" **8972 BK, WT**



Plastic Wire Clip
53255
 1" L • .5" W • .25" H



60W Driver
8900BK
 8.5" L • 2.5" W • 1.5" H
 • 120-277V



100W Driver
8910BK
 9.5" L • 2.5" W • 1.5" H
 • 120-277V

3K | MX-L-120-3K

LED Under Cabinet Lighting



Switch between 3 color temperatures: 4000K, 3000K, and 2700K. All in a 90 CRI for accurate color rendering. The 3K has a patented gimbal designed to allow light to be directed where desired as well as a patented LED strip for even light distribution.

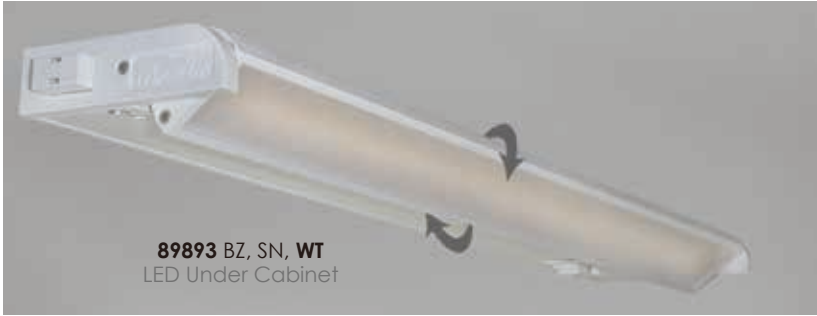

- Patent gimbals to direct illumination
- Patent LED strip for direct and even illumination

Features:

- 3 Color Temperature Options: 4000K, 3000K, 2700K
- CRI 90+
- Dimmable using Triac and Electronic Low Voltage Dimmers
- 40,000 hour rated life
- Linkable end to end or with MX Interlink cord
- Link up to 750 max watts from one power supply
- 120° rotation

Includes:

- 3/8" knockouts on back and bottom
- Romex connector
- Mounting screws

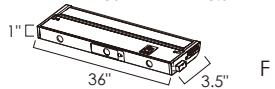
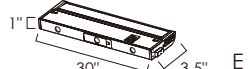
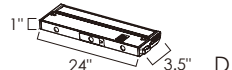
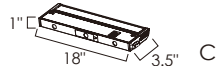
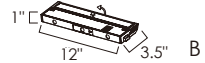

	ITEM #	LAMPING	DIMENSION	HCO	CRI	LUMENS		Additional Info.
						INIT.	DEL.	
A	89892	3W 120V LED 2700-4000K (Incl.)	6"L x 3.5"W x 1.22"H	1.22"	90+	200	175	
B	89893	5W 120V LED 2700-4000K (Incl.)	12"L x 3.5"W x 1"H		90+	320	275	
C	89894	8W 120V LED 2700-4000K (Incl.)	18"L x 3.5"W x 1"H		90+	500	450	
D	89895	12W 120V LED 2700-4000K (Incl.)	24"L x 3.5"W x 1"H		90+	750	650	
E	89896	16W 120V LED 2700-4000K (Incl.)	30"L x 3.5"W x 1"H		90+	1000	900	
F	89897	20W 120V LED 2700-4000K (Incl.)	36"L x 3.5"W x 1"H		90+	1250	1100	

Finish Options: Bronze(BZ) Satin Nickel(SN) White (WT)





2700K Color Temp



3000K Color Temp



4000K Color Temp

ACCESSORIES



MXInterLink4 Direct Wire Box
87885 BK, WT
 2.25"W • 1"H • 5"L



Plastic Wire Clip
53255
 .5"W • .25"H • 1"L
 • Package of 10



MXInterLink4 Connector Cord
87876 BK, WT
 1"W • 5"H • 9"L
87877 BK, WT
 1"W • 5"H • 18"L
87878 BK, WT
 1"W • 5"H • 24"L



MXInterLink4 Power Cord
87880 BK, WT
 72"

2K | MX-L-120-2K

LED Under Cabinet Lighting



A perfect world for under cabinet lighting. Our latest model features 2 color temperatures, warm white and white, both in a 90 CRI for accurate color rendering. Just adjust the switch on the unit to select the best light for your application. Soft and even light is produced using an indirect light design which eliminates spots on the counter surface. Easy to install and connects either end to end or by using the connecting cord included.



89986 AL, BZ, WT
LED Under Cabinet

Features:

- Choice of 2700K or 3200K Color Temperature.
- CRI 90+
- 120 beam spread
- Dimmable using Electronic Low Voltage dimmer
- 50,000 hr. rated life
- Linkable end to end or with MX Interlink 4 cords
- Even light distribution with no counter spots

Includes:

- 3/8" knockouts on back and bottom
- Romex connector included
- 9" connecting cord included

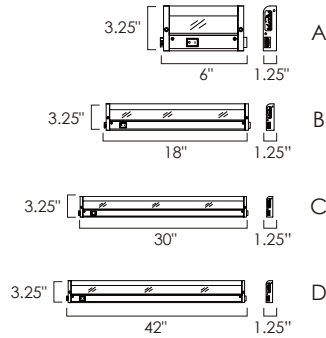

	ITEM #	FINISH	LAMPING	DIMENSION	CRI	LUMENS	Additional Info.
A	89982	AL, BZ, WT	4W LED 2700K/3200K (Incl.)	6"L x 3.25"W x 1.25"H	90+	280	
B	89984	AL, BZ, WT	12W LED 2700K/3200K (Incl.)	18"L x 3.25"W x 1.25"H	90+	840	
C	89986	* BZ, WT	20W LED 2700K/3200K (Incl.)	30"L x 3.25"W x 1.25"H	90+	1400	
D	89988	AL, BZ, WT	28W LED 2700K/3200K (Incl.)	42"L x 3.25"W x 1.25"H	90+	1960	

Finish Options: Brushed Aluminum(AL) Bronze(BZ) White (WT)

*No (AL) finish available





ACCESSORIES



MXInterLink4 Direct Wire Box
87885 BK, WT
 2.25"W • 1"H • 5"L



Plastic Wire Clip
53255
 .5"W • .25"H • 1"L
 • Package of 10



MXInterLink4 Connector Cord
87876 BK, WT
 1"W • 5"H • 9"L
87877 BK, WT
 1"W • 5"H • 18"L
87878 BK, WT
 1"W • 5"H • 24"L



MXInterLink4 Power Cord
87880 BK, WT
 72"

1K | MX-L-120-1K

LED Under Cabinet Lighting



Featuring a defused LED light with an 90+ CRI this 3,000K undercabinet light provides an energy efficient light output at an economical price. Direct wire for easy installation and available in six sizes with a white finish housing, the 1K family is Maxim's starting value in LED undercabinet lighting.



89853WT
LED Under Cabinet

Features:

- Dimmable using Triac dimmer
- 50,000 hour Rated Life
- Direct Wire with knock outs on back, sides and bottom

Includes:

- Mounting Screws
- Romex connector

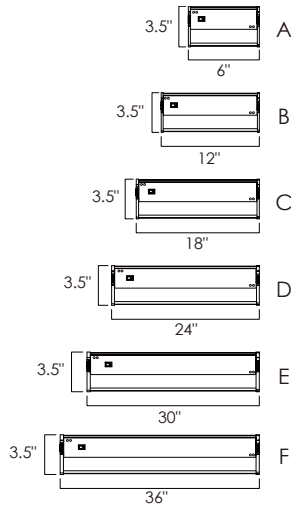

ITEM #	FINISH	LAMPING	DIMENSION	LUMENS		HCOCRI	INIT.	DEL.	Additional Info.
A	89850	WT	3W 120V LED 3000K (Integrated)	6"L x 3.5"W x 1"H	.75"	90	190	150	
B	89851	WT	5W 120V LED 3000K (Integrated)	12"L x 3.5"W x 1"H	.75"	90	320	260	
C	89852	WT	8W 120V LED 3000K (Integrated)	18"L x 3.5"W x 1"H	.75"	90	500	470	
D	89853	WT	12W 120V LED 3000K (Integrated)	24"L x 3.5"W x 1"H	.75"	90	750	670	
E	89854	WT	16W 120V LED 3000K (Integrated)	30"L x 3.5"W x 1"H	.75"	90	1000	830	
F	89855	WT	20W 120V LED 3000K (Integrated)	36"L x 3.5"W x 1"H	.75"	90	1250	1140	

Finish: White (WT)



WT



LO | MX-L120-LO

LED Under Cabinet Lighting



The MX-L120-LO is our economy LED under counter. It features an extruded aluminum body with anodized finishes and a frosted acrylic lens. Its easy mount end caps make for easy and quick installation with captures mounting screws. Can be direct wired with the use of direct wire box or plugged directly into an outlet.



89902 BRZ, WT
LED Under Cabinet

Features:

- CRI 80+
- 40,000 rated life hours
- Linkable end to end or with MX Interlink 5
- Value pricing
- Frosted lens

Includes:

- Two captured mounting screws



• Easy mount end caps



• Can be direct wire box or plugged directly into an outlet.

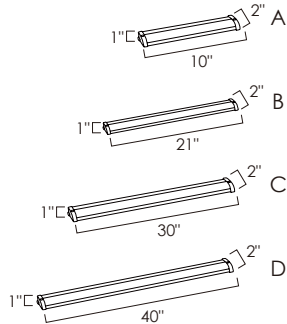

	ITEM #	LAMPING	DIMENSION	CRI	LUMENS	Additional Info.
A	89901	6W 120V LED 3000K (Incl.)	10"L x 2"W x 1"H	80+	390	
B	89902	10W 120V LED 3000K (Incl.)	21"L x 2"W x 1"H	80+	650	
C	89903	12W 120V LED 3000K (Incl.)	30"L x 2"W x 1"H	80+	780	
D	89904	14W 120V LED 3000K (Incl.)	40"L x 2"W x 1"H	80+	910	

Finish: Anodized Bronze(BRZ) White(WT)





ACCESSORIES



MXInterLink5 Direct Wire Box
89958 BK, WT
 2.75"W • 1"H • 6.5"L



Plastic Wire Clip
53255
 .5"W • .25"H • 1"L
 • Package of 10



MXInterLink5 Power Cord
89954 BK, WT
 72"
 • Includes on/off switch



MXInterLink5 Connector Cord
 9" **89951 BK, WT**
 18" **89952 BK, WT**
 24" **89953 BK, WT**

120V XENON | MX-X120

Under Cabinet Lighting



With a sleek profile and direct wiring, this unit installs easily under the cabinet and emits a warm light. The hinged top gives easy access to the long-lasting Xenon bulbs and wiring. Cabinets stay cool and safe, due to the unique airflow design that limits heat transfer.

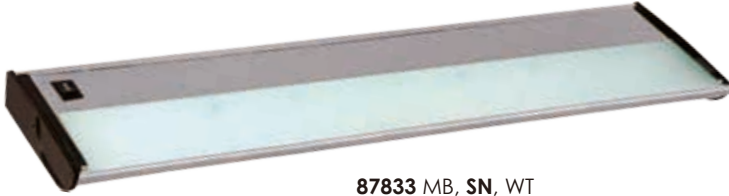

87833 MB, SN, WT
Xenon Under Cabinet

Features:

- Direct wire installation
- Standard Dimmable
- 3,500 rated life hours
- Push-in wire connectors

Includes:

- Xenon 120V bulbs
- Multiple, full size, 1/2" knockouts
- Two captured screws



- Sleek profile 1.25"

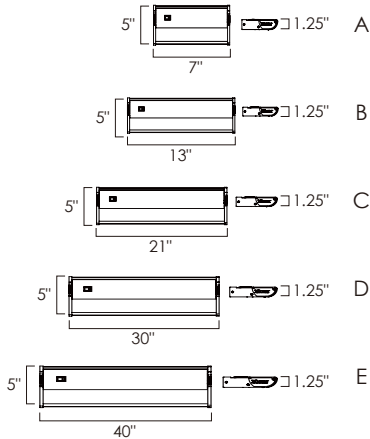

	ITEM # FINISH	LAMPING	DIMENSION	LUMENS	Additional Info.
A	87830 MB, SN, WT	1 x 20W 2900K Xenon Bulb (Incl.)	7"L x 5"W x 1.25"H	225	
B	87831 MB, * WT	2 x 20W 2900K Xenon Bulb (Incl.)	13"L x 5"W x 1.25"H	450	
C	87832 MB, * *	3 x 20W 2900K Xenon Bulb (Incl.)	21"L x 5"W x 1.25"H	675	
D	87833 MB, SN, WT	4 x 20W 2900K Xenon Bulb (Incl.)	30"L x 5"W x 1.25"H	900	
E	87834 MB, SN, WT	5 x 20W 2900K Xenon Bulb (Incl.)	40"L x 5"W x 1.25"H	1125	

Finish: Bronze(MB) Satin Nickel(SN) White (WT)

*No (SN, WT) finish available





LINKABLE XENON | MX-X120c

Linkable 120V Xenon Under Cabinet Lighting



With a sleek profile, linkability and direct wiring, this unit installs easily under the cabinet and emits a warm light. The hinged top gives easy access to the long-lasting Xenon bulbs and wiring. Cabinets stay cool and safe, due to the unique airflow design that limits heat transfer.



87841 MB, WT
Xenon Under Cabinet

Features:

- Linkable with or without cord using MX InterLink 3
- Direct wire installation
- Standard Dimmable
- 3,500 rated life hours
- Push-in wire connectors

Includes:

- Xenon 120V bulbs
- Full Size, 1/2" knockouts



- MX InterLink 3 Direct Wire Junction box
- Knock out for easy wiring

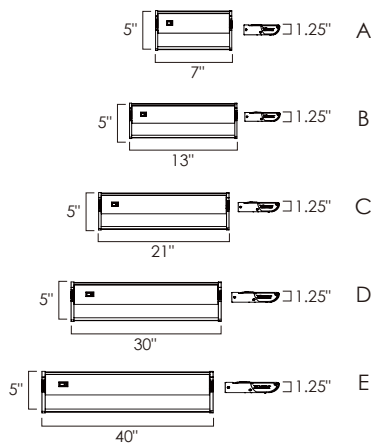

ITEM #	LAMPING	DIMENSION	LUMENS	Additional Info.
A 87840	1 x 20W 2900K Xenon Bulb (Incl.)	7"L x 5"W x 1.25"H	225	
B 87841	2 x 20W 2900K Xenon Bulb (Incl.)	13"L x 5"W x 1.25"H	450	
C 87842	3 x 20W 2900K Xenon Bulb (Incl.)	21"L x 5"W x 1.25"H	675	
D 87843	4 x 20W 2900K Xenon Bulb (Incl.)	30"L x 5"W x 1.25"H	900	
E 87844	5 x 20W 2900K Xenon Bulb (Incl.)	40"L x 5"W x 1.25"H	1125	

Finish: Bronze (MB) White (WT)



MB



WT



ACCESSORIES



MXInterLink3 Direct Wire Box
87850 BK, WT
 5"W • 1"H • 2.25"L



Plastic Wire Clip
53255
 .5"W • .25"H • 1"L
 • Package of 10



MXInterLink3 Connector Cord
 9" **87856WT**
 18" **87857 BK, WT**
 24" **87858 BK, WT**



MXInterLink3 Power Cord
87860BK
 72"L

MX-X12

12V Xenon Under Cabinet Lighting



This ultra low-profile design conceals long-lasting, low-voltage xelogen bulbs that distribute a crisp bright light. Hinged tops allow for convenient bulb replacement and push-in wire connectors in the junction box make either direct wire or plug-in installation quick and simple.



87851 MB, WT
Xenon Under Cabinet

Features:

- Low voltage dimmable
- 10,000 rated life hours
- Airflow design keeps cabinets cool
- Hi-Low adjustable light level switch
- Linkable with or without cord using MX InterLink 3

Includes:

- One MXInterLink3 Direct Wire Box
- One 18" MXInterLink3 Connector Cord
- 12V Xelogen Xenon bulbs included



White
White Accessories

Bronze
Black Accessories

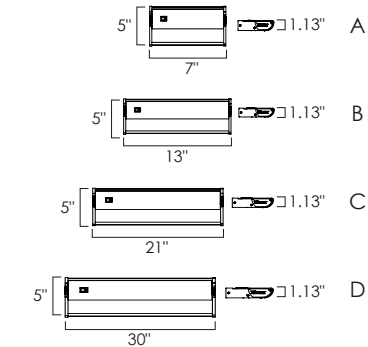

	ITEM #	LAMPING	DIMENSION	LUMENS	Additional Info.
A	87849	1 x 18W 2900K Xenon Bulb (Incl.)	7"L x 5"W x 1.13"H	264	
B	87851	2 x 18W 2900K Xenon Bulb (Incl.)	13"L x 5"W x 1.13"H	528	
C	87852	3 x 18W 2900K Xenon Bulb (Incl.)	21"L x 5"W x 1.13"H	792	
D	87853	4 x 18W 2900K Xenon Bulb (Incl.)	30"L x 5"W x 1.13"H	1056	

ADD-ONS

A	87859	1 x 18W 2900K Xenon Bulb (Incl.)	7"L x 5"W x 1.13"H	264	ADD-ONS
B	87861	2 x 18W 2900K Xenon Bulb (Incl.)	13"L x 5"W x 1.13"H	528	ADD-ONS
C	87862	3 x 18W 2900K Xenon Bulb (Incl.)	21"L x 5"W x 1.13"H	792	ADD-ONS no more WT
D	87863	4 x 18W 2900K Xenon Bulb (Incl.)	30"L x 5"W x 1.13"H	1056	ADD-ONS

Finish: Bronze(MB) White(WT)



MB

WT



ACCESSORIES



MXInterLink3 Direct Wire Box
87850 BK, WT
 5"W • 1"H • 2.25"L



Plastic Wire Clip
53255
 .5"W • .25"H • 1"L
 • Package of 10



MXInterLink3 Connector Cord
 9" **87856WT**
 18" **87857 BK, WT**
 24" **87858 BK, WT**



MXInterLink3 Power Cord
87860BK
 72"L

FLUORESCENT DIRECT | MX-FD

Direct Wire Fluorescent Under Cabinet Lighting



This direct wire collection of fluorescent under cabinet lights boasts T5 high lumen technology. Full size knockouts allow for easy installation in any application.



87806WT

Fluorescent Under Cabinet

- Full Size Knock out for easy wiring

Features:

- T5 high lumens technology
- 7,500 rated life hours
- Non-dimmable

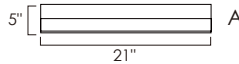

Includes:

- Long life T5 Fluorescent lamps
- Full Size knockouts

ITEM #	LAMPING	DIMENSION	LUMENS	Additional Info.
A 87806	1 F13 T5 3100K 120V (Incl.)	21"L x 5"W x 1.25"H	870	

Finish: White(WT)



AC PUCKS | MX-LD-AC

LED Discs



53835 SN, BRZ, WT
3-Light LED Disc

The versatile CounterMax® MX-LD-AC LED disc features two piece aluminum construction that allows for both surface mounting or recessed installation and are designed for daisy chain installation of up to 20 discs on one driver with direct-wire installation. Fully dimmable with ELV and Triac dimmers. This combination of versatility, safety, energy efficiency and dimmability make the MX-LD-AC LED discs the smart choice for disc lighting.

Features:

- Surfaced or Recessed installation with 30° swivel
- 2700K and 3000K Color Temperature, CRI 90+
- Line Voltage Construction, no driver needed
- Die Cast Aluminum Construction
- Aluminum heat sink
- Link up to 20 units on single power supply
- 6" Leads on both ends
- 12" and 24" Connecting Cord Available
- Dimmable with Triac Dimmer
- Not suitable for enclosed cabinets



- Link up to 20 units on single power supply

Includes:

- Two Mounting Screws
- One 12" Connecting Cord



- Two piece Aluminum Construction for both Surface and Recessed Installation



White (WT)



Satin Nickel (SN)



Anodized Bronze (BRZ)

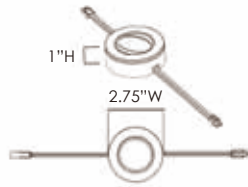

- Junction box includes multiply knockouts for easy mounting

ITEM #	LAMPING	DIMENSION	LUMENS				Additional Info.
			CRI	INIT.	DEL.		
53830	1 x 4W 120V LED 3000K (Integrated)	2.75"L x 2.75"W x 1"H	90+	250	200		
53832	1 x 4W 120V LED 2700K (Integrated)	2.75"L x 2.75"W x 1"H	90+	250	200		
53835*	3 x 4W 120V LED 3000K (Integrated)	2.75"L x 2.75"W x 1"H	90+	250	200		
53836*	3 x 4W 120V LED 2700K (Integrated)	2.75"L x 2.75"W x 1"H	90+	250	200		

Finish: Anodized Bronze (BRZ) Satin Nickel(SN) White (WT)

*Package of 3 discs



ACCESSORIES



Junction Box
53838 BK, WT
 4"L • 2.5"W • 1"H



Power Cord
53885 BK, WT
 72"L



Connecting Cord
 12" **53886 BK, WT**



Connecting Cord
 24" **53887 BK, WT**

DC PUCKS | MX-LD-D

LED Discs



53860 AL, BRZ, WT
LED Disc

The versatile CounterMax® MX-LD-D LED disc features two piece aluminum construction that allows for both surface mounting or recessed installation and are designed for daisy chain installation of up to nine discs on one driver with direct-wire installation. MX-LD-D LED discs are dimmable using a standard dimmer. This combination of versatility, safety, energy efficiency, and dimmability make the MX-LD-D LED disc the smart choice for disc lighting.

Features:

- 3000K Color Temperature
- Dimmable using a standard dimmer
- 40,000 rated life hours
- Surface or recessed installation
- Two 12" wire leads (Black for Anodized Bronze and Brushed Aluminum finishes, White for White finish)
- Twist lock connectors
- 24 volt low voltage lighting system
- Frosted light guard diffuser



- Up to nine MX-LD-D LED discs on a single driver

Includes:

- Two clear mount clips with 3M Tape
- Two mounting screws

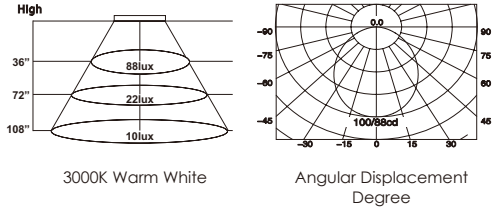

Recessed



Surface

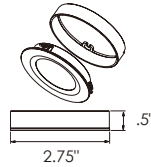

- Two piece Aluminum Construction for both Surface and Recessed Installation

ITEM #	LAMPING	DIMENSION	CRI	LUMENS	Additional Info.
53860	2.3W LED 3000K (Integrated)	2.75"W x .5"H	80+	220	

Finish Options: Brushed Aluminum (AL) Anodized Bronze (BRZ) White (WT)





ACCESSORIES



Extension Cords
 12" **53868 BK, WT**
 24" **53869 BK, WT**

- Extends distance between driver and MX-LD-D LED disc
- Extends distance between any two MX-LD-D LED discs
- Maximum amount of extension cords on a single driver is 120"



24V 20W Direct Wire Driver
 7.75"L • 2"W • 1.25"H
53878BK



24V 30W Direct Wire Driver
 9.5"L • 2"W • 1.25"H
53879BK

Input	110V-277V	110V-2770V
Output	24V, 83A output	24V, 1.25A output
Operates	Up To 6 Discs	Up To 9 Discs
Output Cord	32F to 104F	32F to 104F
Junction	Junction	Junction
Dimmable	Dimmable	Dimmable

LOW PROFILE

Give the most discreet parts of your home a new light, with Maxim's low profile lighting collection, showcasing several different styles and configurations. Featuring sleek, understated designs these collections offer unbelievable lighting perfect for hallways, closets, kitchens, and more. The fixtures may be discreet, but the light cast is anything but.



COVE

The Cove Series is the perfect substitute to traditional recessed fixture because it requires no recessed housing. In addition to being Energy Star and Title 24 listed, it is IC Airtight and Fire Rated making it adapt to broad requirements of existing and new construction. Aesthetically, its coved design allows for the light to shine indirectly providing even illumination and reducing harsh glare of similar products

Features:

- 4" and 6" Recessed Can Substitute
- UL Outlet Box fitted on fixture
- Dimmable with Triac Dimmer
- Good for new construction and remodels
- Indirect lighting for soft-even illumination
- IC-Rated for direct contact with insulation
- Damp Location Rated
- Fire Rated is only for 4" model with Rough-In Plate
- Title 24



57790
Cove Rough-In Plate



57794WT
Recessed Downlight

A



57796WT
Recessed Downlight

B

	ITEM # LAMPING	DIMENSION	HCO CRI	LUMENS	Additional Info.
A	57794 9W LED 3000K (Inte.)	4.75"L x 4.75"W x 3.25"H	3.3" 90+	540	Fire rated
B	57796 12W LED 3000K (Inte.)	6.75"L x 6.75"W x 3.75"H	3.8" 90+	720	Fire rated

Finish: White (WT)

LED WRAP



This modern era utility fixture has the perfect combination of economical operation and low maintenance. No longer do you have to change fluorescent tubes as this new design features dual full length LED boards for ample light and even distribution.



- Choice of Color Temperature: 3000K and 4000K
- CRI 90+
- Dimmable with Triac Dimmer
- Energy Star
- Title 24
- Damp Location



57521WT
Flush Mount

A



57522WT
Flush Mount

B



57523WT
Flush Mount

C

ITEM #	LAMPING	DIMENSION	LUMENS			Additional Info.
			CRI	INIT.	DEL.	
A	57521 40W LED 4000K (Integrated)	48"L x 4"W x 4.5"H	90+	3800	3230	
B	57522 40W LED 3000K (Integrated)	48"L x 4"W x 4.5"H	90+	3800	3230	
C	57523 40W LED 3000K (Integrated)	48"L x 7"W x 2.5"H	80+	4200	4000	Not Dimmable, 110-277V Input

Finish: White (WT)

Sky makes large scale edge lit LED panels easy for both residential and commercial uses. With a user-friendly mounting bracket and integrated driver, this product lends itself to quick installations. High powered LED modules with 110-277V capability with your choice of dimming and classic finishes to suit any setting.



- 120-277V Input
- Dimmability Options: 0-10V or ELV
- Finish Options: White, Bronze, Brushed Aluminum
- Color Temperatures: 3000K and 4000K
- CRI 90
- Energy Star
- Wet Location Rated



57762 WTAL, **WTBZ**, **WTWT**
57772WTWT
Flush Mount

A



57764 WTAL, **WTBZ**, **WTWT**
57774WTWT
Flush Mount

B

	ITEM #	LAMPING	DIMENSION	CRI	LUMENS	Additional Info.
A	57762	22W LED 3000K (Integrated)	23.5"L x 11.75"W x .75"H	90+	1760	120-277V Input
A	57772	22W LED 3000K (Integrated)	23.5"L x 11.75"W x .75"H	90+	1760	120-277V Input
B	57764	45W LED 3000K (Integrated)	48"L x 11.75"W x .75"H	90+	3600	120-277V Input
B	57774	45W LED 3000K (Integrated)	48"L x 11.75"W x .75"H	90+	3600	120-277V Input

Finish Options: White glass(WT) Brushed Aluminum (AL) Bronze (BZ) White(WT)

WAFER



Wafer was designed for the discriminate consumer who wants the low profile look of recessed without the high cost. Manufactured of die cast aluminum, Wafer brings ultimate heat dissipation to its edge lit technology. Edge lighting gives very even light distribution while dispersing heat over a larger area. The result of this is longer LED life and better light diffusion.



- *57736, 57737 and 57738 require a 4" junction box
- Die Cast Aluminum
- Edge Lit LED technology
- Available in White, Bronze, and Satin Nickel finishes
- Choice of 4 Size Options between 5" and 15"
- Thin profile of 0.5"
- Wet location rated
- Dimmable with Triac and Electronic Low Voltage Dimmers
- Energy Star
- Title 24 options



57720 WT~~BZ~~, WTSN, WTWT
Flush/Wall Mount

A

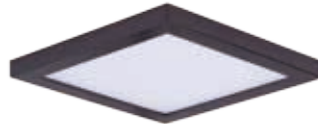

57722 WT~~BZ~~, WTSN, WTWT
Flush/Wall Mount

B



57724 WT~~BZ~~, WTSN, WTWT
Flush/Wall Mount

C



***57738** WT~~BZ~~, WTSN, WTWT *Installs to 4" Junction Box
57739 WTWT
Flush/Wall Mount

D

ITEM #	LAMPING	DIMENSION	LUMENS			Additional Info.
			CRI	INIT.	DEL.	
A	57720 10W 120V LED 3000K (Inte.)	4.5"L x 4.5"W x .5"H	90+	700	600	
B	57722 15W 120V LED 3000K (Inte.)	6.25"L x 6.25"W x .5"H	90+	1050	900	
C	57724 20W 120V LED 3000K (Inte.)	9"L x 9"W x .5"H	90+	1400	1200	
D	57738 36W LED 3000K (Inte.)	15"L x 15"W x .5"H	90+	2500	2200	120-277V input
D	57739 36W LED 4000K (Inte.)	15"L x 15"W x .5"H	90+	2500	2600	120-277V input

Finish: White glass (WT) Bronze (BZ) Satin Nickel (SN) White (WT)



• Easy to Install, Low profile, Edge Lit LED technology



57710 WTBZ, WTSN, WTWT
57711 WTWT
 Flush/Wall Mount
 E



57712 WTBZ, WTSN, WTWT
57713 WTWT
 Flush/Wall Mount
 F



57714 WTBZ, WTSN, WTWT
57715 WTWT
 Flush/Wall Mount
 G



*Installs to 4" Junction Box
***57736** WTBZ, WTSN, WTWT
***57737** WTWT
 Flush/Wall Mount
 H



57780WT
 Empty shell



57784WTWT
 Flush Mount
 • 1.5 Hours Emergency
 Back UP

ITEM #	LAMPING	DIMENSION	CRI	LUMENS		Additional Info.
				INIT.	DEL.	
E	57710 : 10W 120V LED 3000K (Inte.)	5" L x 5" W x .5" H	90+	700	600	120-277V Input, 0-10V Dimming
E	57711 : 10W LED 3000K (Inte.)	5" L x 5" W x .5" H	90+	660	800	120-277V Input, 0-10V Dimming
F	57712 : 15W 120V LED 3000K (Inte.)	7" L x 7" W x .5" H	90+	1050	900	120-277V Input, 0-10V Dimming
F	57713 : 15W LED 3000K (Inte.)	7" L x 7" W x .5" H	90+	1050	900	120-277V Input, 0-10V Dimming
	57780 : Add on shell	7" L x 7" W x 1.25" H	90+			1.5 Hours Emergency Back Up
	57784 : 15W 120V LED 3000K (Inte.)	7" L x 7" W x 1.75" H	90+	1100	900	1.5 Hours Emergency Back Up
G	57714 : 20W 120V LED 3000K (Inte.)	10" L x 7" W x .5" H	90+	1400	1200	120-277V Input, 0-10V Dimming
G	57715 : 20W LED 3000K (Inte.)	10" L x 10" W x .5" H	90+	1200	1200	120-277V Input, 0-10V Dimming
H	57736 : 36W LED 3000K (Inte.)	15" L x 15" W x .5" H	90+	2500	2200	120-277V input
H	57737 : 36W LED 4000K (Inte.)	15" L x 15" W x .5" H	90+	2500	2500	120-277V input

Finish: White glass (WT) Bronze (BZ) Satin Nickel (SN) White (WT)

WAFER



- New models feature 120-277V input
- Dimmable at 120V using Electronic Low Voltage dimmer
- Color Temperatures: 3000K and 4000K
- CRI 90+
- Energy Star
- Wet Location Rated
- *Installs to 4" Junction Box



***57742WTWT**
***57743WTWT**
 Flush Mount

A



***57746WTWT**
***57747WTWT**
 Flush Mount

B

ITEM #	LAMPING	DIMENSION	LUMENS				Additional Info.
			HCO	CRI	INIT.	DEL.	
A 57742	18W LED 3000K (Inte.)	24"L x 4.5"W x .5"H	5"	90+	1300	1300	120-277V Input
A 57743	18W LED 4000K (Inte.)	24"L x 4.5"W x .5"H	5"	90+	1380	1300	120-277V Input
B 57746	36W LED 3000K (Inte.)	48"L x 4.5"W x .5"H	5"	90+	3200	2500	120-277V Input
B 57747	36W LED 4000K (Inte.)	48"L x 4.5"W x .5"H	5"	90+	3200	2600	120-277V Input

Finish: White glass (WT) White (WT)

CHIP

The entry level Wafer model features driverless technology with the same great look. Manufactured of a plastic shell with aluminum backing, the Chip brings all the look of the Wafer at economical pricing for residential applications. The bright and even lighting effect is delivered by edge-lit technology offering an upscale surface mount solution to substitute recessed can lighting.

Features:

- Size options between 5" and 7" apertures
- Available in 3000k (Made-to-order Color Temperatures available)
- Suitable for Closets according to NEC Section 410.8 & 410.16
- Available in White (WT) and Satin Nickel (SN)
- Dimmable with Triac and ELV Dimmers
- Easy to install: fits in 3-0 and 4-0 Outlet Box (pancake and mud ring acceptable)
- Pendant light accessory available (sold separately)
- Edge-Lit LED Technology
- Suitable for Wet Location, for use on ceilings outdoor and above showers
- cETLus



57692 WTSN, WTWT
Flush/Wall Mount

B



57690 WTSN, WTWT
Flush/Wall Mount

A



57695 WTSN, WTWT
Flush/Wall Mount

C



57697 WTSN, WTWT
Flush/Wall Mount

D

ITEM #	LAMPING	DIMENSION	LUMENS			Additional Info.
			CRI	INIT.	DEL.	
A	57690 : 12W 120V PCB LED 3000K (Inte.)	5.25"L x 5.25"W x .5"H	90+	880	780	
B	57692 : 15W 120V PCB LED 3000K (Inte.)	7"L x 7"W x .5"H	90+	1080	980	
C	57695 : 12W 120V PCB LED 3000K (Inte.)	4.75"L x 4.75"W x .5"H	90+	880	780	
D	57697 : 15W 120V PCB LED 3000K (Inte.)	6.25"L x 6.25"W x .5"H	90+	1080	980	

Finish Options: White glass (WT) Satin Nickel (SN) White (WT)

ILLUMINAIRE II



Our ever popular flush mount available in an updated form. Featuring die-cast aluminum bases available in Satin Nickel or Polished Chrome with dimensional acrylic diffusers, Clear on the outside and Frost on the inside creating an intriguing optical effect. With increased lumens and better pricing this collection is the second generation in an already famous collection. Use the optional pendant adapter to convert any size to a hanging fixture.



57600 BZ, PC, SN

Pendant Kit (*Light Sold Separately*)

E



57683 CLFTBZ, CLFTPC, CLFTSN
Flush Mount

C



57680 CLFTBZ, CLFTPC, CLFTSN
Flush Mount

A



57684 CLFTBZ, CLFTPC, CLFTSN
Flush Mount

D



57682 CLFTBZ, CLFTPC, CLFTSN
Flush Mount

B

	ITEM #	LAMPING	DIMENSION	LUMENS			Additional Info.
				CRI	INIT.	DEL.	
A	57680	12.5W PCB LED 3000K (Integrated)	5"W x 1.75"H	90+	920	820	
B	57682	15W PCB LED 3000K (Integrated)	7"W x 1.75"H	90+	1080	980	
C	57683	18W PCB LED 3000K (Integrated)	9"W x 1.75"H	90+	1270	1170	
D	57684	20W PCB LED 3000K (Integrated)	11"W x 1.75"H	90+	1400	1300	
E	57600		2.25"W x 10.75"H				

Finish Options: Clear glass (CL) Frosted glass (FT) Bronze (BZ) Polished Chrome (PC) Satin Nickel (SN)

Features:

- Die Cast Aluminum
- Size options between 5", 7", 9", and 11"
- Available in 3000k (Made-to-order Color Temperatures available)
- Thick acrylic etched on the inside to give dimension
- Suitable for Closets according to NEC Section 410.8 & 410.16
- Available in Polished Chrome (PC) and Satin Nickel (SN)
- Dimmable with Triac and ELV Dimmers
- Easy to install: fits in 3-0 and 4-0 Outlet Box (pancake and mud ring acceptable)
- Pendant light accessory available (sold separately)
- Edge-Lit LED Technology
- Suitable for Wet Location, for use on ceilings outdoor and above showers
- ETL/CETL IP65



57686 CLFTBZ, CLFTPC, CLFTSN
Flush Mount

F



57687 CLFTBZ, CLFTPC, CLFTSN
Flush Mount

G



57688 CLFTBZ, CLFTPC, CLFTSN
Flush Mount

H



57689 CLFTBZ, CLFTPC, CLFTSN
Flush Mount

I

ITEM #	LAMPING	DIMENSION	CRI	LUMENS		Additional Info.
				INIT.	DEL.	
F	57686 : 12.5W PCB LED 3000K (Integrated)	4.75"W x 1.75"H	90+	920	820	
G	57687 : 15W PCB LED 3000K (Integrated)	6.25"W x 1.75"H	90+	1080	980	
H	57688 : 18W PCB LED 3000K (Integrated)	8.5"W x 1.75"H	90+	1270	1170	
I	57689 : 20W PCB LED 3000K (Integrated)	10.5"W x 1.75"H	90+	1400	1300	

Finish Options: Clear glass (CL) Frosted glass (FT) Bronze (BZ) Polished Chrome (PC) Satin Nickel (SN)

TRIM



Thin discs of evenly illuminated LED create the impression of recessed lighting.



The die-cast aluminum housings are available in White, Black, Satin Nickel, and Polished Chrome all with a thoughtfully recessed White polycarbonate diffuser. High efficiency

and good color rendering make this a perfect choice for your next project. Use the optional pendant adapter to convert any size to a hanging fixture.



57600 BZ, PC, SN, WT

Pendant Kit (*Light Sold Separately*)

E



57660 **WTBK, WTPC, WTSN, WTWT**
Flush/Wall Mount

A



57662 **WTBK, WTPC, WTSN, WTWT**
Flush/Wall Mount

B



57663 **WTBK, WTPC, WTSN, WTWT**
Flush/Wall Mount

C



57664 **WTBK, WTPC, WTSN, WTWT**
Flush/Wall Mount

D

	ITEM #	LAMPING	DIMENSION	LUMENS			Additional Info.
				CRI	INIT.	DEL.	
A	57660	12.5W PCB LED 3000K (Integrated)	5"W x .75"H	90+	920	875	
B	57662	15W PCB LED 3000K (Integrated)	7"W x .75"H	90+	1100	1050	
C	57663	18W PCB LED 3000K (Integrated)	9"W x .75"H	90+	1280	1260	
D	57664	20W PCB LED 3000K (Integrated)	11"W x .75"H	90+	1450	1400	
E	57600		2.25"W x 10.75"H				

Finish Options: White glass (WT) Black (BK) Polished Chrome (PC) Satin Nickel (SN) White (WT)

Features:

- Die Cast Aluminum
- Size options between 5", 7", 9", and 11"
- Ultra-thin ½" height with less than ¼" trim
- Available in 3000K (Made-to-order Color Temperatures available)
- Suitable for Closets according to NEC Section 410.8 & 410.16
- Available in White (WT), Black (BK), Polished Chrome (PC) and Satin Nickel (SN)
- Dimmable with Triac and ELV Dimmers
- Easy to install: fits in 3-0 and 4-0 Outlet Box (pancake and mud ring acceptable)
- Pendant light accessory available (sold separately)
- Edge-Lit LED Technology
- Suitable for Wet Location, for use on ceilings outdoor and above showers
- ETL/CETL IP65



57665 WTBK, WTPC, WTSN, WTWT
Flush/Wall Mount

F



57667 WTBK, WTPC, WTSN, WTWT
Flush/Wall Mount

G



57668 WTBK, WTPC, WTSN, WTWT
Flush/Wall Mount

H



57669 WTBK, WTPC, WTSN, WTWT
Flush/Wall Mount

I

ITEM #	LAMPING	DIMENSION	CRI	LUMENS		Additional Info.
				INIT.	DEL.	
F	57665 : 12.5W PCB LED 3000K (Integrated)	4.75"W x .75"H	90+	920	875	
G	57667 : 15W PCB LED 3000K (Integrated)	6.25"W x .75"H	90+	1100	1050	
H	57668 : 18W PCB LED 3000K (Integrated)	8.5"W x .75"H	90+	1280	1260	
I	57669 : 20W PCB LED 3000K (Integrated)	10.5"W x .75"H	90+	1450	1400	

Finish Options: White glass (WT) Black (BK) Polished Chrome (PC) Satin Nickel (SN) White (WT)

DIVERSE



This very compact LED flush mount easily installs on any 3.25" octagon box and gives the look of a recessed trim. Constructed of Die Cast Aluminum, the Diverse luminaire is dimmable and also approved for wet locations so it can be used in virtually any ceiling application, including showers.



RFK5762
Retrofit Kit With Bracket
for items 57622, 57624,
57625, 57627, 57640, 57647
Sold separately



RFK57652
Retrofit Kit
Without Bracket
for item 57652
Sold separately



57622 WTBZ, WTSN, WTWT
57624 WTBZ, WTSN, WTWT
Flush Mount

A



57625 WTSN
57627 WTSN
Flush Mount

B



57641 WTWT
57647 WTWT
57644 WTWT
Flush Mount

D



57651 WTWT
57652 WTBZ, WTSN, WTWT
57654 WTWT
Flush Mount

E



57640 WTBZ, WTSN, WTWT
Flush Mount

C



87610 WTSN, WTWT
Flush Mount

F

ITEM #	LAMPING	DIMENSION	LUMENS			Additional Info.
			CRI	INIT.	DEL.	
A 57622	12W 120V LED 2700K (Inte.)	5.75"L x 5.75"W x 1"H	90+	800	750	
A 57624	12W 120V LED 3000K (Inte.)	5.75"L x 5.75"W x 1"H	90+	800	850	
B 57625	15W 120V LED 2700K (Inte.)	7.5"L x 7.5"W x 1.25"H	90+	1000	950	
B 57627	15W 120V LED 3000K (Inte.)	7.5"L x 7.5"W x 1.25"H	90+	1000	950	
C 57640	28W 120V LED 3000K (Inte.)	13"L x 13"W x .75"H	90+	1850	1320	
D 57641	15W 120V LED 2700K (Inte.)	7.5"L x 7.5"W x 1.25"H	90+	1350	1050	
D 57647	15W 120V LED 3000K (Inte.)	7.5"L x 7.5"W x 1.25"H	90+	1350	1050	
D 57644	15W 120V LED 4000K (Inte.)	7.5"L x 7.5"W x 1.25"H	90+	1350	1050	
E 57651	12.5W 120V LED 2700K (Inte.)	7.5"L x 7.5"W x 1.25"H	90+	1100	950	
E 57652	12.5W 120V LED 3000K (Inte.)	7.5"L x 7.5"W x 1.25"H	90+	1100	950	
E 57654	12.5W 120V LED 4000K (Inte.)	7.5"L x 7.5"W x 1.25"H	90+	1100	950	
F 87610	10W 120V LED 3000K (Inte.)	6.5"L x 6.5"W x 1.5"H	80+	700	425	

Finish: White glass (WT) Bronze (BZ) Satin Nickel (SN) White (WT)

Features:

- Die Cast Aluminum
- 3000K Color Temperature
- CRI 80+ and CRI 90+ options available
- For residential use only
- Suitable for wet or damp locations
- Dimmable with Triac Dimmer



57631WTWT
57633WTWT
57636WTWT
 Flush Mount

G



57850 WT BZ, WTSN, WTWT
57851 WTWT
57852 WTWT
57853 WTWT
 Flush Mount

H



57855 WT BZ, WTSN, WTWT
57856 WTWT
57857 WTWT
57858 WTWT
 Flush Mount

I



57860 WT BZ, WTSN, WTWT
57861 WTWT
57862 WTWT
57863 WTWT
 Flush Mount

J

ITEM #	LAMPING	DIMENSION	CRI	LUMENS		Additional Info.
				INIT.	DEL.	
G	57631 12W PCB LED 2700K (Inte.)	6.25"L x 6.25"W x 1.25"H	90+	1080	850	
G	57633 12W PCB LED 3000K (Inte.)	6.25"L x 6.25"W x 1.25"H	90+	1080	850	
G	57636 12W PCB LED 4000K (Inte.)	6.25"L x 6.25"W x 1.25"H	90+	1080	850	
H	57850 18W PCB LED 3000K (Inte.)	9.25"L x 9.25"W x 1.25"H	90+	1620	1260	
H	57851 18W PCB LED 2700K (Inte.)	9.25"L x 9.25"W x 1.25"H	90+	1620	1260	
H	57852 18W PCB LED 3000K (Inte.)	9.25"L x 9.25"W x 1.25"H	90+	1620	1260	
H	57853 18W PCB LED 4000K (Inte.)	9.25"L x 9.25"W x 1.25"H	90+	1620	1260	
I	57855 20W PCB LED 3000K (Inte.)	11"L x 11"W x 1.75"H	90+	1800	1400	
I	57856 20W PCB LED 2700K (Inte.)	11"L x 11"W x 1.75"H	90+	1800	1400	
I	57857 20W PCB LED 3000K (Inte.)	11"L x 11"W x 1.75"H	90+	1800	1400	
I	57858 20W PCB LED 4000K (Inte.)	11"L x 11"W x 1.75"H	90+	1800	1400	
J	57860 25W PCB LED 3000K (Inte.)	13"L x 13"W x 1.75"H	90+	2250	1750	
J	57861 25W PCB LED 2700K (Inte.)	13"L x 13"W x 1.75"H	90+	2250	1750	
J	57862 25W PCB LED 3000K (Inte.)	13"L x 13"W x 1.75"H	90+	2250	1750	
J	57863 25W PCB LED 4000K (Inte.)	13"L x 13"W x 1.75"H	90+	2250	1750	

Finish: White glass (WT) Bronze (BZ) Satin Nickel (SN) White (WT)

CONVERT



Now you can convert a standard 3" outlet box to a low profile LED recessed fixture. Convert's patent pending design allows for the driver to install into an electrical box, which requires no fire rated cover. This creates a fixture with only a 1" extension from the ceiling. High efficiency and smooth dimming down to 5% makes this an excellent choice for hallways, kitchens, and utility lighting.



Features

- 2800K or 4000K Color Temperature
- CRI 80+
- Beam spread 110°
- Dimmable to 5%
- 110V Input Voltage
- Power Factor 90+
- THD less than 10%
- Suitable for damp location



87615WTWT
87617WTWT
Flush Mount

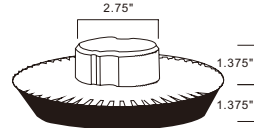

Installs into 3 1/4" and 4" electrical box, with a minimum 2.5" depth

New Construction:

- Mounts to 3 1/4" and 4" J-Box with a minimum depth of 2.25"
- Converts standard electrical box to a recessed styled fixture
- 1" extension
- Cast Aluminum heat sink provides long LED diode life
- Commercial and Residential application
- High powered dimmable LED
- Cost effective solution for Fire Rated Downlighting applications, as there is no need for fire rated covers

Recommended Dimmers:

- Lutron MACL-153M
Lutron DVL-153P
Lutron SCL-153P
- Leviton IPL06-10Z
Leviton 6674-POW
- The Convert is designed to dim with a standard Triac forward phase dimmer. Dimming levels will vary by dimmer.
- Due to the inrush, current wattage should not exceed 150 Watts of product for a 600 Watt dimmer.



	ITEM #	LAMPING	DIMENSION	CRI	LUMENS	Additional Info.
A	87615	15W 120V LED 2800/2900K (Incl.)	8"L x 8"W x 1"H	80+	1050	
A	87617	15W 120V LED 4000K (Incl.)	8"L x 8"W x 1"H	80+	1100	

Finish: White glass (WT) White (WT)



SERIES DETAILS

Series	Item	Measurements	Lamping	Lumens	Color Temp	Life Hours	Installation	Replacement Bulb
Fluorescent Direct MX-FD	87806	5"W x 1.25"H x 21"L	1 x 13W Mini Bi Pin T5	870	3100	7500	DW	BUFT513012
1K MX-L-120-1K	89850	3.5"W x 1"H x 6"L, .75"HCO	3W 120V LED, CR190	190 +150	3000	50000	DW	
	89851	3.5"W x 1"H x 12"L, .75"HCO	5W 120V LED, CR190	320 +260	3000	50000	DW	
	89852	3.5"W x 1"H x 18"L, .75"HCO	8W 120V LED, CR190	500 +470	3000	50000	DW	
	89853	3.5"W x 1"H x 24"L, .75"HCO	12W 120V LED, CR190	750 +670	3000	50000	DW	
	89854	3.5"W x 1"H x 30"L, .75"HCO	16W 120V LED, CR190	1000 +830	3000	50000	DW	
	89855	3.5"W x 1"H x 36"L, .75"HCO	20W 120V LED, CR190	1250 +1140	3000	50000	DW	
2K MX-L-120-2K	89982	3.25"W x 1.25"H x 6"L	4W LED	280	2700 /3200	50000	DW, CP4, Dw4, L4	
	89984	3.25"W x 1.25"H x 18"L	12W LED	840	2700 /3200	50000	DW, CP4, Dw4, L4	
	89986	3.25"W x 1.25"H x 30"L	20W LED	1400	2700 /3200	50000	DW, CP4, Dw4, L4	
	89988	3.25"W x 1.25"H x 42"L	28W LED	1960	2700 /3200	50000	DW, CP4, Dw4, L4	
3K MX-L-120-3K	89892	3.5"W x 1.22"H x 6"L 1.22"HCO	3W 120V LED, CR190+	200 +175	2700 -4000	40000	DW, CP4, Dw4, L4	
	89893	3.5"W x 1"H x 12"L	5W 120V LED, CR190+	320 +275	2700 -4000	40000	DW, CP4, Dw4, L4	
	89894	3.5"W x 1"H x 18"L	8W 120V LED, CR190+	500 +450	2700 -4000	40000	DW, CP4, Dw4, L4	
	89895	3.5"W x 1"H x 24"L	12W 120V LED, CR190+	750 +650	2700 -4000	40000	DW, CP4, Dw4, L4	
	89896	3.5"W x 1"H x 30"L	16W 120V LED, CR190+	1000 +900	2700 -4000	40000	DW, CP4, Dw4, L4	
	89897	3.5"W x 1"H x 36"L	20W 120V LED, CR190+	1250 +1100	2700 -4000	40000	DW, CP4, Dw4, L4	
LO MX-L-120-LO	89901	2"W x 1"H x 10"L	6W 120V LED, CR180+	390	3000	40000	DW, CP5, Dw5, L5	
	89902	2"W x 1"H x 21"L	10W 120V LED, CR180+	650	3000	40000	DW, CP5, Dw5, L5	
	89903	2"W x 1"H x 30"L	12W 120V LED, CR180+	780	3000	40000	DW, CP5, Dw5, L5	
	89904	2"W x 1"H x 40"L	14W 120V LED, CR180+	910	3000	40000	DW, CP5, Dw5, L5	
SLIM LINE MX-L-120-SL	88900	4.5"W x .25"H x 6"L .25"HCO	3W 24V LED, CR190+	210 +180	3000	40000		
	88901	4.5"W x .25"H x 12"L .25"HCO	6W 24V LED, CR190+	420 +360	2700	40000		
	88902	4.5"W x .25"H x 24"L .25"HCO	12W 24V LED, CR190+	840 +720	3000	40000		
	88903	4.5"W x .25"H x 36"L .25"HCO	18W 24V LED, CR190+	1260 +1080	2700	40000		
	88904	4.5"W x .25"H x 48"L .25"HCO	24W 24V LED, CR190+	1680 +1440	2700	40000		
SLIM STICK MX-L-24-SS	89800	.75"W x .5"H x 6"L	3W 24V LED, CR190+	350 +195	3000			
	89801	.75"W x .5"H x 12"L	5W 24V LED, CR190+	700 +390	3000			
	89802	.75"W x .5"H x 24"L	10W 24V LED, CR190+	1050 +780	3000			
	89803	.75"W x .5"H x 36"L	15W 24V LED, CR190+	1400 +1170	3000			
	89804	.75"W x .5"H x 48"L	20W 24V LED, CR190+	1560 +1400	3000			

Series	Item	Measurements	Lamping	Lumens	Color Temp	Life Hours	Installation	Replacement Bulb
AC PUCKS MX-LD-AC	53830	2.75"W x 1"H	1 x 4W LED, CRI90+	250 +200	3000			
	53832	2.75"W x 1"H	1 x 4W LED, CRI90+	250 +200	2700			
	53835	2.75"W x 1"H	3 x 4W LED, CRI90+	250 +200	3000			
	53836	2.75"W x 1"H	3 x 4W LED, CRI90+	250 +200	2700			
DC PUCKS MX-LD-D	Single Disc	2.75"W x .5"H	1 x 2.3W LED, CRI80+	220	3000	40000	CP	
MX-X12	87849/87859	5"W x 1.125"H x 7"L	1 x 18W Wedge T5 Xelogen	264	2900	10000	CP3, DW3, IL3	BUX20023
	87851/87861	5"W x 1.125"H x 13"L	2 x 18W Wedge T5 Xelogen	528	2900	10000	CP3, DW3, IL3	BUX20023
	87852/87862	5"W x 1.125"H x 21"L	3 x 18W Wedge T5 Xelogen	792	2900	10000	CP3, DW3, IL3	BUX20023
	87853/87863	5"W x 1.125"H x 30"L	4 x 18W Wedge T5 Xelogen	1056	2900	10000	CP3, DW3, IL3	BUX20023
120V XENON MX-X120	87830	5"W x 1.25"H x 7"L	1 x 20W C8	225	2900	3500	DW	BUX20016
	87831	5"W x 1.25"H x 13"L	2 x 20W C8	450	2900	3500	DW	BUX20016
	87832	5"W x 1.25"H x 21"L	3 x 20W C8	675	2900	3500	DW	BUX20016
	87833	5"W x 1.25"H x 30"L	4 x 20W C8	900	2900	3500	DW	BUX20016
	87834	5"W x 1.25"H x 40"L	5 x 20W C8	1125	2900	3500	DW	BUX20016
LINKABLE XENON MX-X120c	87840	5"W x 1.25"H x 7"L	1 x 20W C8	225	2900	3500	DW, CP3, DW3, IL3	BUX20016
	87841	5"W x 1.25"H x 13"L	2 x 20W C8	450	2900	3500	DW, CP3, DW3, IL3	BUX20016
	87842	5"W x 1.25"H x 21"L	3 x 20W C8	675	2900	3500	DW, CP3, DW3, IL3	BUX20016
	87843	5"W x 1.25"H x 30"L	4 x 20W C8	900	2900	3500	DW, CP3, DW3, IL3	BUX20016
	87844	5"W x 1.25"H x 40"L	5 x 20W C8	1125	2900	3500	DW, CP3, DW3, IL3	BUX20016

Cord and Plug

CP - Cord/Plug
 CP2 - MXInterLink2 Cord/Plug
 CP3 - MXInterLink3 Cord/Plug
 CP4 - MXInterLink4 Cord/Plug
 CP5 - MXInterLink5 Cord/Plug

Direct Wire

DW - Direct Wire
 DW2 - MXInterLink2 Direct Wire Box
 DW3 - MXInterLink3 Direct Wire Box
 DW4 - MXInterLink4 Direct Wire Box
 DW5 - MXInterLink5 Direct Wire Box

Link Connector

IL2 - MXInterLink2 Connector Cord
 IL3 - MXInterLink3 Connector Cord
 IL4 - MXInterLink4 Connector Cord
 IL5 - MXInterLink5 Connector Cord

DISPLAYS

Showcase your products right with our informative displays.



A



B



C



D

ITEM #	DIMENSION	Additional Info.
A DSP055WT		Wall Display
B DSP054BK		Rolling Display
C DSP044WT	28"W x 4.5"H x 6"L	1 Level Bulb Display (Bulbs not Included)
D DSP043WT	28"W x 9.5"H x 14.5"L	2 Level Bulb Display (Bulbs not Included)

Finish: Black (BK) White (WT)



E



F



G



H

	ITEM #	DIMENSION	Additional Info.
E	DSP041GY	19"W x 15"H x 9.5"L	CounterMax 3K Display (Small)
F	DSP040GY	28"W x 18.25"H x 11"L	CounterMax 3K Display (Large)
G	DSP042BK	16"W x 17.25"H x 11"L	Cove Display (Fixtures Included)
H	DSP053BK		Wafer/Diverse Display (Bulbs not Included)

Finish: Black (BK) Gray (GY)

INDEX

8900.....	8	57720.....	33	87885.....	10, 12
8910.....	8	57722.....	33	88900.....	7
8912.....	8	57724.....	33	88901.....	7
8924.....	8	57736.....	34	88902.....	7
8972.....	8	57737.....	34	88903.....	7
53255.....	8, 10, 12, 16, 20, 22	57738.....	33	88904.....	7
53830.....	25	57739.....	33	89800.....	5
53832.....	25	57742.....	35	89801.....	5
53835.....	25	57743.....	35	89802.....	5
53836.....	25	57746.....	35	89803.....	5
53838.....	26	57747.....	35	89804.....	5
53860.....	27	57762.....	32	89811.....	6
53868.....	28	57764.....	32	89812.....	6
53869.....	28	57772.....	32	89814.....	6
53878.....	28	57774.....	32	89816.....	6
53879.....	28	57780.....	34	89818.....	6
53885.....	26	57784.....	34	89820.....	6
53886.....	26	57790.....	30	89821.....	6
53887.....	26	57794.....	30	89822.....	6
57521.....	31	57796.....	30	89824.....	6
57522.....	31	57850.....	42	89826.....	6
57523.....	31	57851.....	42	89828.....	6
57600.....	37, 39	57852.....	42	89830.....	6
57622.....	41	57853.....	42	89831.....	6
57624.....	41	57855.....	42	89835.....	6
57625.....	41	57856.....	42	89850.....	13
57627.....	41	57857.....	42	89851.....	13
57631.....	42	57858.....	42	89852.....	13
57633.....	42	57860.....	42	89853.....	13
57636.....	42	57861.....	42	89854.....	13
57640.....	41	57862.....	42	89855.....	13
57641.....	41	57863.....	42	89892.....	9
57644.....	41	87610.....	41	89893.....	9
57647.....	41	87615.....	43	89894.....	9
57651.....	41	87617.....	43	89895.....	9
57652.....	41	87806.....	23	89896.....	9
57654.....	41	87830.....	17	89897.....	9
57660.....	39	87831.....	17	89901.....	15
57662.....	39	87832.....	17	89902.....	15
57663.....	39	87833.....	17	89903.....	15
57664.....	39	87834.....	17	89904.....	15
57665.....	40	87840.....	19	89951.....	16
57667.....	40	87841.....	19	89952.....	16
57668.....	40	87842.....	19	89953.....	16
57669.....	40	87843.....	19	89954.....	16
57680.....	37	87844.....	19	89958.....	16
57682.....	37	87849.....	21	89982.....	11
57683.....	37	87850.....	20, 22	89984.....	11
57684.....	37	87851.....	21	89986.....	11
57686.....	38	87852.....	21	89988.....	11
57687.....	38	87853.....	21	DSP040GY.....	48
57688.....	38	87856.....	20, 22	DSP041GY.....	48
57689.....	38	87857.....	20, 22	DSP042BK.....	48
57690.....	36	87858.....	20, 22	DSP043WT.....	47
57692.....	36	87859.....	21	DSP044WT.....	47
57695.....	36	87860.....	20, 22	DSP053BK.....	48
57697.....	36	87861.....	21	DSP054BK.....	47
57710.....	34	87862.....	21	DSP055WT.....	47
57711.....	34	87863.....	21	RFK5762.....	41
57712.....	34	87876.....	10, 12	RFK57652.....	41
57713.....	34	87877.....	10, 12		
57714.....	34	87878.....	10, 12		
57715.....	34	87880.....	10, 12		

LEGEND



LED



ADA
Compliant



Dark Sky



Dimmable



For Damp Location



For Wet Location



Slope



Installs
Up or Down



Die Cast Aluminum



Energy Star
Certified

Installing new ENERGY STAR qualified light fixtures is a smart way to save energy and money. Maxim Lighting is proud to be an ENERGY STAR partner. Look for this ENERGY STAR logo to find Maxim Lighting fixtures that use 1/4 of the energy of traditional incandescent fixtures and last up to 10 times longer. More information on ENERGY STAR can be found on the ENERGY STAR web site at energystar.gov.



California
Title 20

All new homes, additions, alterations and most commercial buildings in California must meet minimum energy efficiency standards contained in Title 24, Part 6 of the California Code of Regulations. When you see the California Title 24 symbol next to a Maxim Lighting fixture, you can be assured that the fixture complies. More information on California Title 24 can be found on the California Energy Commission web site at energy.ca.gov/title24.



California
Title 24

Warranty And Other Information

- For specific and detailed warranty information, ask your Maxim Lighting sales representative or visit www.maximlighting.com/warranty.
- Maxim Lighting reserves the right to change details of design, materials, colors and finishes. Color may vary from what is pictured due to limitations inherent to the photographic process.
- Always consult a qualified, licensed electrician before installation of any product weighing 35 pounds or more. We recommend that a qualified, licensed electrician do installations. Always install to a mechanically sound structure.
- Products in this supplement are UL or ETL certified. All electrical products are certified and listed to standards for use in the United States of America or Canada.
- Bulbs are not included unless otherwise noted.

CounterMax and Maxim Lighting are registered trademarks of Maxim Lighting International, Inc. All designs, logos, products and images © Copyright 2020 Maxim Lighting International, Inc. All Rights Reserved. Printed in China

LMXCAT1909



Maxim Lighting International

253 North Vineland Avenue
City of Industry, California
91746
USA

General Info: 626.956.4200
Customer Service: 800.486.2946
General Fax: 626.956.4226

Dallas Trade Mart: 214.748.8455
Showroom: 3901
Email: info@maximlighting.com
Web: maximlighting.com